



User Manual

----- **SOLAR INVERTER** -----

VM II Premium 1.2K & 2.5K

Table Of Contents

| | |
|------------------------------------------------------------------------------|-----------|
| ABOUT THIS MANUAL | 1 |
| Purpose | 1 |
| Scope | 1 |
| SAFETY INSTRUCTIONS | 1 |
| INTRODUCTION | 2 |
| Features | 2 |
| Basic System Architecture | 2 |
| Product Overview..... | 3 |
| INSTALLATION | 4 |
| Unpacking and Inspection..... | 4 |
| Preparation | 4 |
| Mounting the Unit..... | 4 |
| Battery Connection | 5 |
| AC Input/Output Connection | 7 |
| PV Connection | 9 |
| Final Assembly..... | 11 |
| Communication Options..... | 11 |
| BMS Communication | 11 |
| OPERATION | 12 |
| Power ON/OFF | 12 |
| Operation and Display Panel | 12 |
| LCD Display Icons | 13 |
| LCD Setting..... | 15 |
| Display Setting | 22 |
| Operating Mode Description | 25 |
| Battery Equalization Description | 27 |
| Fault Reference Code..... | 29 |
| Warning Indicator..... | 29 |
| CLEARANCE AND MAINTENANCE FOR ANTI-DUST KIT | 30 |
| Overview | 30 |
| Clearance and Maintenance | 30 |
| SPECIFICATIONS | 31 |
| Table 1 Line Mode Specifications | 31 |
| Table 2 Inverter Mode Specifications | 32 |
| Table 3 Charge Mode Specifications | 33 |
| Table 4 General Specifications | 33 |
| TROUBLE SHOOTING | 34 |
| Appendix I: BMS Communication Installation | 35 |
| Appendix II: The Wi-Fi Operation Guide in Remote Panel (Option) | 42 |

ABOUT THIS MANUAL

Purpose

This manual describes the assembly, installation, operation and troubleshooting of this unit. Please read this manual carefully before installations and operations. Keep this manual for future reference.

Scope

This manual provides safety and installation guidelines as well as information on tools and wiring.

SAFETY INSTRUCTIONS



WARNING: This chapter contains important safety and operating instructions. Read and keep this manual for future reference.

1. Before using the unit, read all instructions and cautionary markings on the unit, the batteries and all appropriate sections of this manual.
2. **CAUTION** --To reduce risk of injury, charge only deep-cycle lead acid type rechargeable batteries. Other types of batteries may burst, causing personal injury and damage.
3. Do not disassemble the unit. Take it to a qualified service center when service or repair is required. Incorrect re-assembly may result in a risk of electric shock or fire.
4. To reduce risk of electric shock, disconnect all wirings before attempting any maintenance or cleaning. Turning off the unit will not reduce this risk.
5. **CAUTION** – Only qualified personnel can install this device with battery.
6. **NEVER** charge a frozen battery.
7. For optimum operation of this inverter/charger, please follow required spec to select appropriate cable size. It's very important to correctly operate this inverter/charger.
8. Be very cautious when working with metal tools on or around batteries. A potential risk exists to drop a tool to spark or short circuit batteries or other electrical parts and could cause an explosion.
9. Please strictly follow installation procedure when you want to disconnect AC or DC terminals. Please refer to INSTALLATION section of this manual for the details.
10. One piece of 150A fuse is provided as over-current protection for the battery supply.
11. GROUNDING INSTRUCTIONS -This inverter/charger should be connected to a permanent grounded wiring system. Be sure to comply with local requirements and regulation to install this inverter.
12. NEVER cause AC output and DC input short circuited. Do NOT connect to the mains when DC input short circuits.
13. **Warning!!** Only qualified service persons are able to service this device. If errors still persist after following troubleshooting table, please send this inverter/charger back to local dealer or service center for maintenance.
14. **WARNING:** Because this inverter is non-isolated, only three types of PV modules are acceptable: single crystalline, poly crystalline with class A-rated and CIGS modules. To avoid any malfunction, do not connect any PV modules with possible current leakage to the inverter. For example, grounded PV modules will cause current leakage to the inverter. When using CIGS modules, please be sure NO grounding.
15. **CAUTION:** It's requested to use PV junction box with surge protection. Otherwise, it will cause damage on inverter when lightning occurs on PV modules.

INTRODUCTION

This is a multi-function inverter/charger, combining functions of inverter, solar charger and battery charger to offer uninterruptible power support with portable size. Its comprehensive LCD display offers user-configurable and easy-accessible button operation such as battery charging current, AC/solar charger priority, and acceptable input voltage based on different applications.

Features

- Pure sine wave inverter
- Built-in BMS communication port
- Built-in anti-dust kit
- Inverter running without battery
- Configurable input voltage range for home appliances and personal computers via LCD setting
- Configurable battery charging current based on applications via LCD setting
- Configurable AC/Solar Charger priority via LCD setting
- Compatible to mains voltage or generator power
- Overload/ Over temperature/ short circuit protection
- Smart battery charger design for optimized battery performance

Basic System Architecture

The following illustration shows basic application for this inverter/charger. It also includes following devices to have a complete running system:

- Generator or Utility.
- PV modules

Consult with your system integrator for other possible system architectures depending on your requirements.

This inverter can power all kinds of appliances in home or office environment, including motor-type appliances such as tube light, fan, refrigerator and air conditioner.

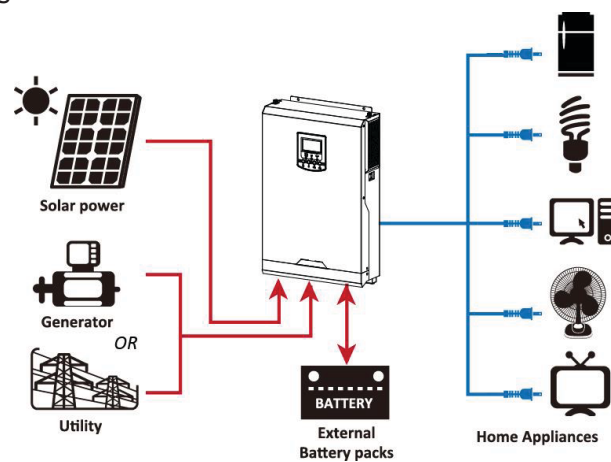
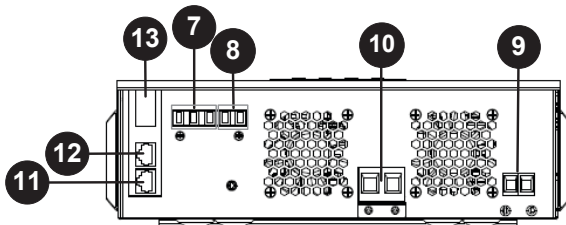
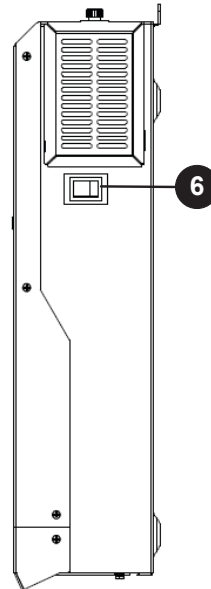
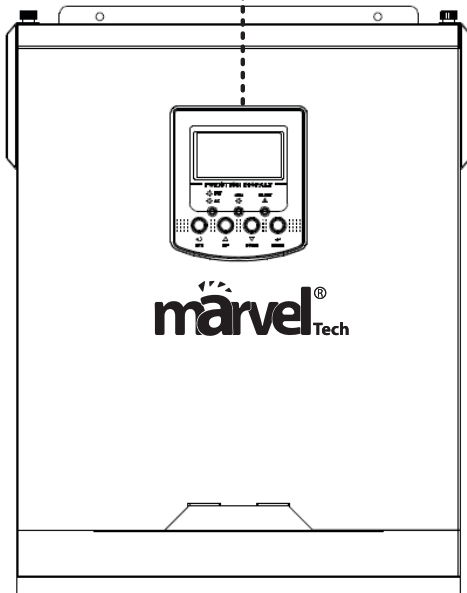
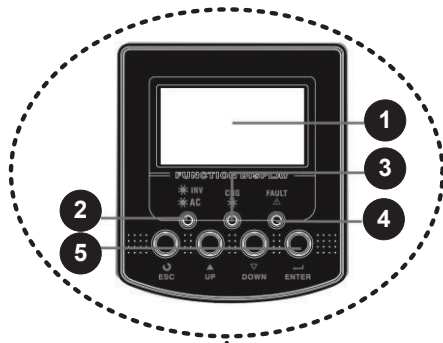
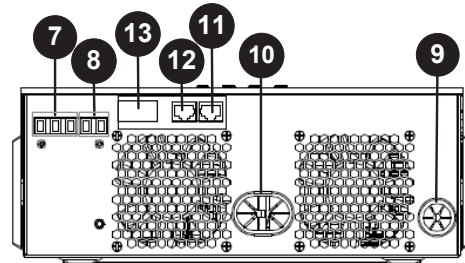

Figure 1 Hybrid Power System

Product Overview



1.2KVA/2.5KVA models



3KVA model

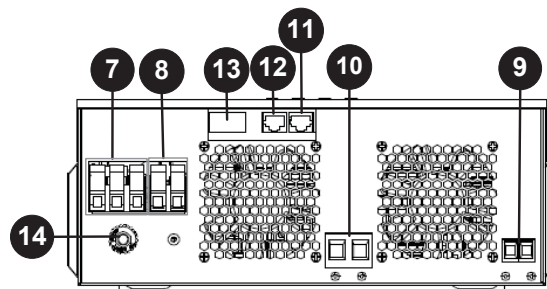

5KVA model

1. LCD display
2. Status indicator
3. Charging indicator
4. Fault indicator
5. Function buttons
6. Power on/off switch
7. AC input
8. AC output
9. PV input
10. Battery input
11. RS-232 communication port
12. BMS communication port
13. Optional WiFi
14. Input Circuit breaker

INSTALLATION

Unpacking and Inspection

Before installation, please inspect the unit. Be sure that nothing inside the package is damaged. You should have received the following items inside of package:

- The unit x 1
- User manual x 1
- Communication cable x 1
- Software CD x 1
- Ring terminal for Ground x 1
- Strain relief plate x 1 (Only for 1.2KVA/2.5KVA/5KVA models)
- Screws x 2 (Only for 1.2KVA/2.5KVA/5KVA models)
- DC Fuse x 1 (Only for 5KVA models)

Preparation

Before connecting all wirings, please take off bottom cover by removing screws as shown below.

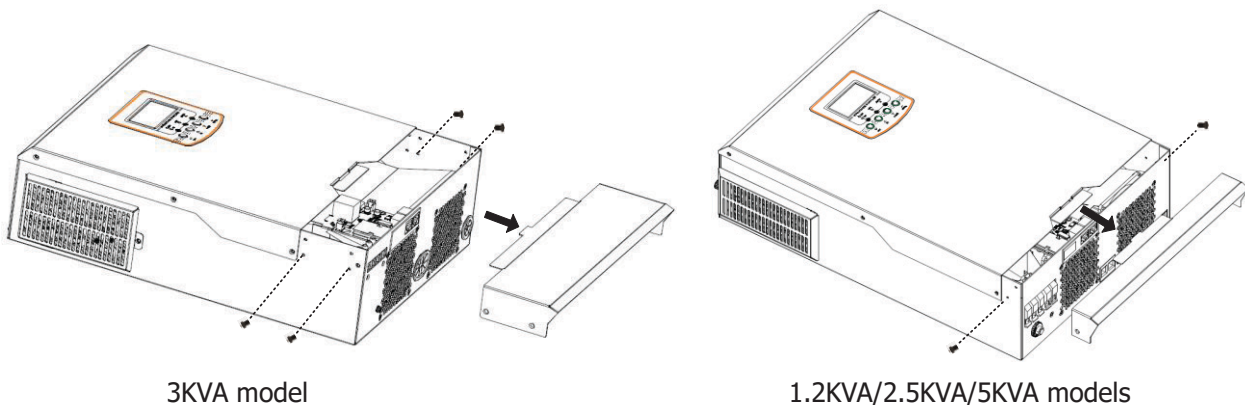

Mounting the Unit

Consider the following points before selecting where to install:

- Do not mount the inverter on flammable construction materials.
- Mount on a solid surface
- Install this inverter at eye level in order to allow the LCD display to be read at all times.
- For proper air circulation to dissipate heat, allow a clearance of approx. 20 cm to the side and approx. 50 cm above and below the unit.
- The ambient temperature should be between 0°C and 55°C to ensure optimal operation.
- The recommended installation position is to be adhered to the wall vertically.
- Be sure to keep other objects and surfaces as shown in the diagram to guarantee sufficient heat dissipation and to have enough space for removing wires.

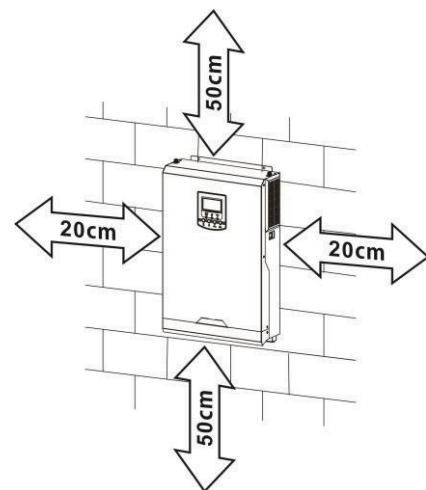

SUITABLE FOR MOUNTING ON CONCRETE OR OTHER NON-COMBUSTIBLE SURFACE ONLY.

Install the unit by screwing two screws. It's recommended to use M4 or M5 screws.

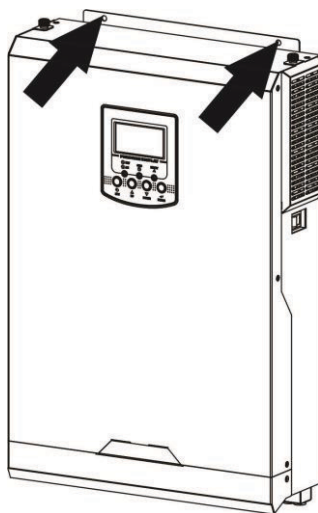

Battery Connection

This model can be operated without battery connection. Connect to battery if necessary.

CAUTION: For safety operation and regulation compliance, it's requested to install a separate DC over-current protector or disconnect device between battery and inverter. It may not be requested to have a disconnect device in some applications, however, it's still requested to have over-current protection installed. Please refer to typical amperage in below table as required fuse or breaker size.

WARNING! All wiring must be performed by a qualified personnel.

WARNING! It's very important for system safety and efficient operation to use appropriate cable for battery connection. To reduce risk of injury, please use the proper recommended cable as below.

Recommended battery cable size:

| Model | Wire Size | Cable (mm ²) | Torque value (max) |
|---------------|-----------|--------------------------|----------------------|
| 1.2KVA/2.5KVA | 1 x 4AWG | 25 | 2 Nm |
| 3KVA/5KVA | 1 x 2AWG | 35 | 2 Nm |

Please follow below steps to implement battery connection:

- For 1.2KVA/2.5KVA/5KVA models, remove insulation sleeve 18 mm for positive and negative conductors. Suggest to put bootlace ferrules on the end of positive and negative wires with a proper crimping tool.

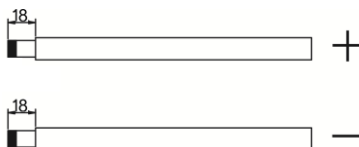

For 3KVA models, refer to recommended battery spec table to purchase separately two ring terminals and battery wires. Assemble two ring terminals with battery wires based on recommended battery cable and terminal size as grounding cable. Recommended dimensions for ring terminal is D (8.4 mm) and L (39.2 mm).

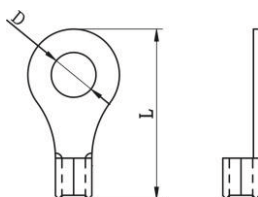

- This step is only for 1.2KA/2.5KVA/5KVA models. Fix strain relief plate to the inverter with supplied screws as shown in below chart.

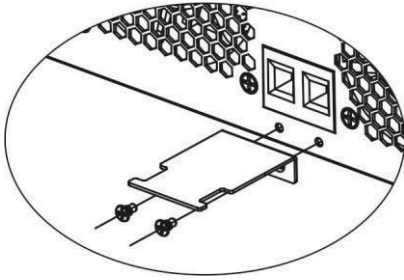

- Connect all battery packs as below chart. It is recommend to connect at least 100Ah capacity battery.

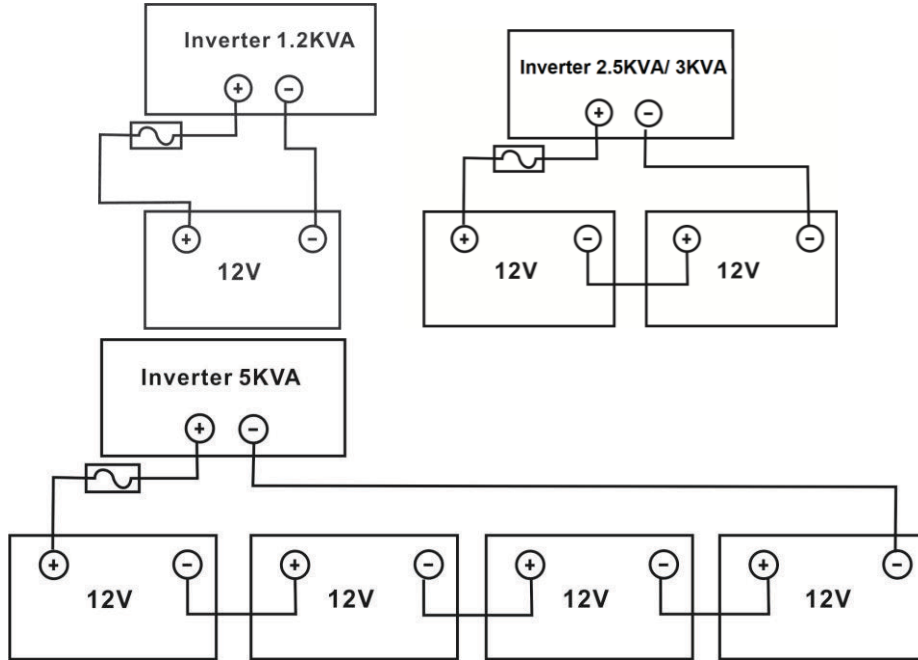

- For 1.2KVA/2.5KVA/5KVA models, insert the battery wires flatly into battery connectors of inverter and make sure the bolts are tightened with torque of 2 Nm in clockwise direction. Make sure polarity at both the battery and the inverter/charge is correctly connected and conductors are tightly screwed into the battery terminals.

Recommended tool: #2 Pozi Screwdriver

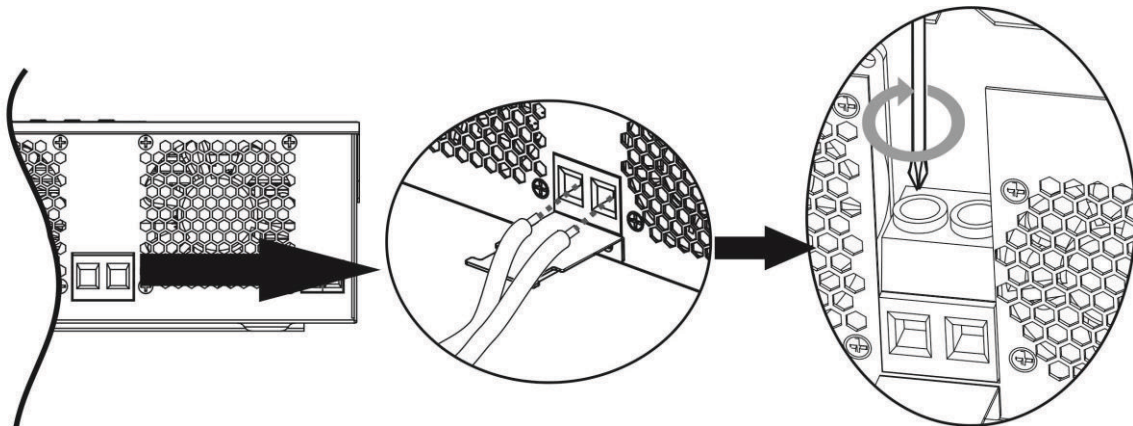

For 3KVA model, secure assembled ring terminals to the battery terminal block with the bolts properly tightened. Refer to battery cable size for torque value. Make sure polarity at both the battery and the inverter is correctly connected and ring terminals are secured to the battery terminals.

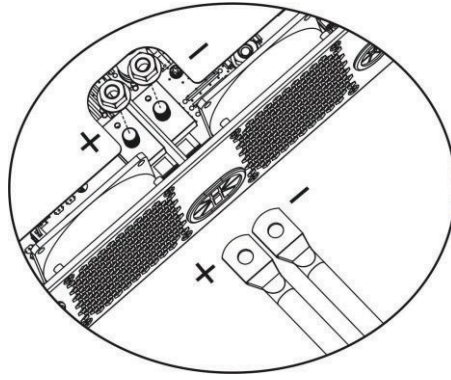

5. This step is only for 1.2KA/2.5KVA/5KVA models. To firmly secure wire connection, you may fix the wires to strain relief with cable tie.

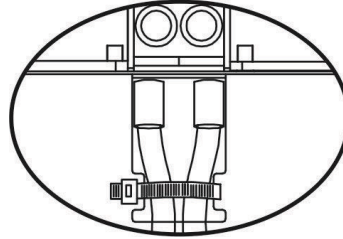

WARNING: Shock Hazard

Installation must be performed with care due to high battery voltage in series.



CAUTION!! Do not place anything between inverter terminals and the ring terminals. Otherwise, overheating may occur.

CAUTION!! Do not apply anti-oxidant substance on the terminals before terminals are securely tightened.

CAUTION!! Before making the final DC connection or closing DC breaker/disconnector, be sure positive (+) must be connected to positive (+) and negative (-) must be connected to negative (-).

AC Input/Output Connection

CAUTION!! Before connecting to AC input power source, please install a **separate** AC breaker between inverter and AC input power source. This will ensure the inverter can be securely disconnected during maintenance and fully protected from over current of AC input. The recommended spec of AC breaker is 20A.

CAUTION!! There are two terminal blocks with "IN" and "OUT" markings. Please do NOT mis-connect input and output connectors.

WARNING! All wiring must be performed by a qualified personnel.

WARNING! It's very important for system safety and efficient operation to use appropriate cable for AC input connection. To reduce risk of injury, please use the proper recommended cable size as below.

Suggested cable requirement for AC wires

| Model | Gauge | Cable (mm ²) | Torque Value |
|-------------|--------|--------------------------|--------------|
| 1.2KVA | 16 AWG | 1.5 | 0.6 Nm |
| 2.5KVA/3KVA | 14 AWG | 2.5 | 0.6 Nm |
| 5KVA | 10 AWG | 6 | 1.2 Nm |

Please follow below steps to implement AC input/output connection:

1. Before making AC input/output connection, be sure to open DC protector or disconnector first.

- Remove insulation sleeve 10mm for six conductors. And shorten phase L and neutral conductor N 3 mm.
- Insert AC input wires according to polarities indicated on terminal block and tighten the terminal screws. Be sure to connect PE protective conductor (⊕) first.

⊕→**Ground (yellow-green)**

L→**LINE (brown or black)**

N→**Neutral (blue)**

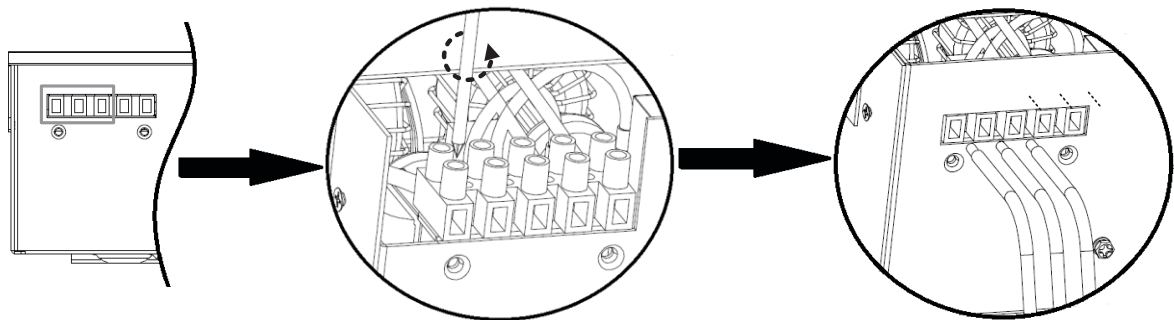

1.2KVA/2.5KVA/3KVA models

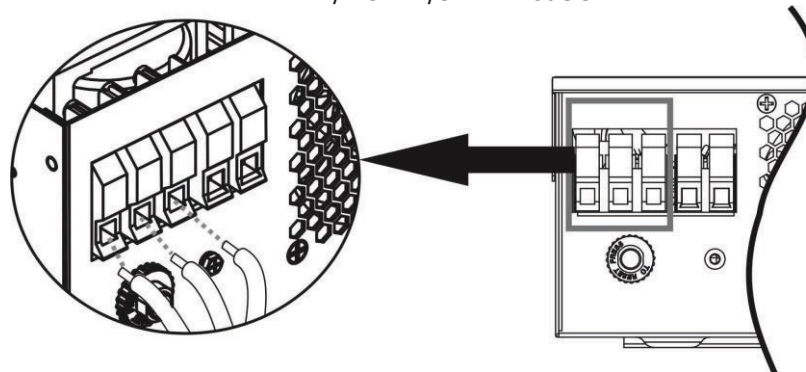

5KVA model



WARNING:

Be sure that AC power source is disconnected before attempting to hardwire it to the unit.

- Then, insert AC output wires according to polarities indicated on terminal block and tighten terminal screws. Be sure to connect PE protective conductor (⊕) first.

⊕→**Ground (yellow-green)**

L→**LINE (brown or black)**

N→**Neutral (blue)**

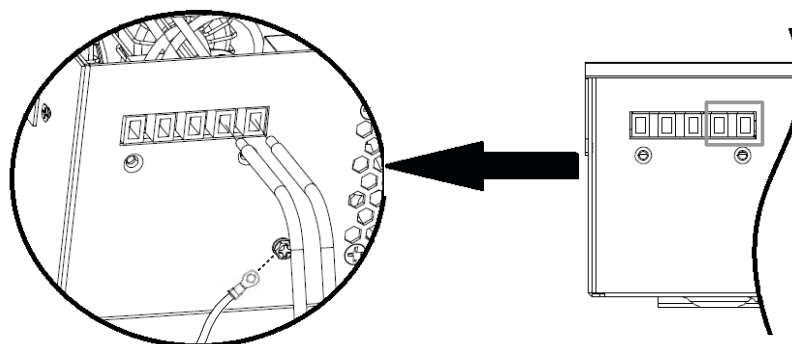

1.2KVA/2.5KVA/3KVA models

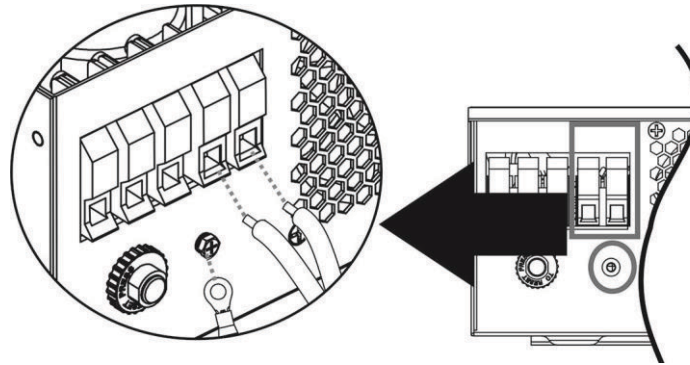

5KVA model

5. Make sure the wires are securely connected.

CAUTION: Appliances such as air conditioner are required at least 2~3 minutes to restart because it's required to have enough time to balance refrigerant gas inside of circuits. If a power shortage occurs and recovers in a short time, it will cause damage to your connected appliances. To prevent this kind of damage, please check manufacturer of air conditioner if it's equipped with time-delay function before installation. Otherwise, this inverter/charger will trig overload fault and cut off output to protect your appliance but sometimes it still causes internal damage to the air conditioner.

PV Connection

CAUTION: Before connecting to PV modules, please install **separately** a DC circuit breaker between inverter and PV modules.

WARNING! It's very important for system safety and efficient operation to use appropriate cable for PV module connection. To reduce risk of injury, please use the proper recommended cable size as below.

| Wire Size | Cable (mm ²) | Torque value (max) |
|-----------|--------------------------|----------------------|
| 1 x 12AWG | 4 | 1.2 Nm |

WARNING: Because this inverter is non-isolated, only three types of PV modules are acceptable: single crystalline, poly crystalline with class A-rated and CIGS modules.

To avoid any malfunction, do not connect any PV modules with possible current leakage to the inverter. For example, grounded PV modules will cause current leakage to the inverter. When using CIGS modules, please be sure NO grounding.

CAUTION: It's requested to use PV junction box with surge protection. Otherwise, it will cause damage on inverter when lightning occurs on PV modules.

Never directly touch the terminals of inverter. It might cause lethal electric shock.

PV Module Selection:

When selecting proper PV modules, please be sure to consider below parameters:

1. Open circuit Voltage (Voc) of PV modules not exceeds max. PV array open circuit voltage of inverter.
2. Open circuit Voltage (Voc) of PV modules should be higher than min. battery voltage.

| INVERTER MODEL | 1.2KVA | 2.5KVA | 3KVA | 5KVA |
|------------------------------------|-----------|-----------|------|---------------|
| Max. PV Array Open Circuit Voltage | 350Vdc | 450Vdc | | 500Vdc |
| PV Array MPPT Voltage Range | 60~300Vdc | 60~400Vdc | | 120Vdc~450Vdc |

Take 250Wp PV module as an example. After considering above two parameters, the recommended module configurations are listed as below table.

| Solar Panel Spec. (reference) - 250Wp - Vmp: 30.1Vdc - Imp: 8.3A - Voc: 37.7Vdc - Isc: 8.4A - Cells: 60 | SOLAR INPUT | | Q'ty of panels | Total input power |
|------------------------------------------------------------------------------------------------------------------------------|----------------------------------------------------------------------------------------------------------------------------------------|--|----------------|-------------------|
| | (1.2KVA/2.5KVA/3KVA models: Min in serial: 3 pcs, max. in serial: 12 pcs; 5KVA model: Min in serial: 3 pcs, max. in serial: 13 pcs) | | | |
| | 3 pcs in serial | | 3 pcs | 750W |
| | 6 pcs in serial | | 6 pcs | 1500W |
| | 8 pcs in serial | | 8 pcs | 2000W |
| | 12 pcs in serial | | 12 pcs | 3000W |
| | 13 pcs in serial (only for 5KVA model) | | 13 pcs | 3250W |
| | 8 pieces in serial and 2 sets in parallel (only for 5KVA model) | | 16 pcs | 4000W |
| | 10 pieces in serial and 2 sets in parallel (only for 5KVA model) | | 20 pcs | 5000W |

PV Module Wire Connection

Please follow below steps to implement PV module connection:

1. Remove insulation sleeve 10 mm for positive and negative conductors.
2. Suggest to put bootlace ferrules on the end of positive and negative wires with a proper crimping tool.
3. Check correct polarity of wire connection from PV modules and PV input connectors. Then, connect positive pole (+) of connection wire to positive pole (+) of PV input connector. Connect negative pole (-) of connection wire to negative pole (-) of PV input connector. Screw two wires tightly in clockwise direction.

Recommended tool: 4mm blade screwdriver

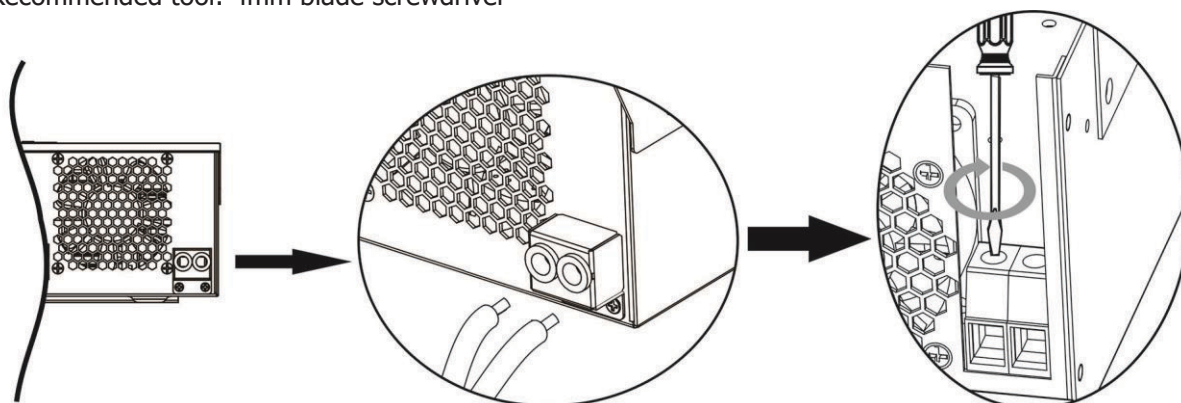
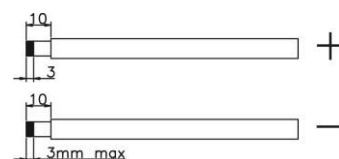

1.2KVA/2.5KVA/5KVA models

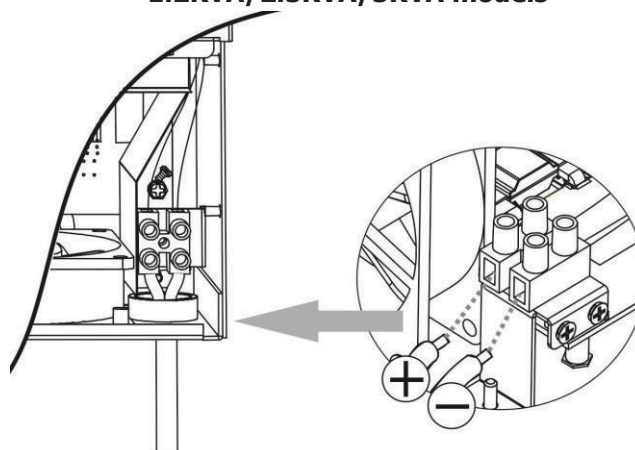

3KVA model

Final Assembly

After connecting all wirings, please put bottom cover back by screwing screws as shown below.

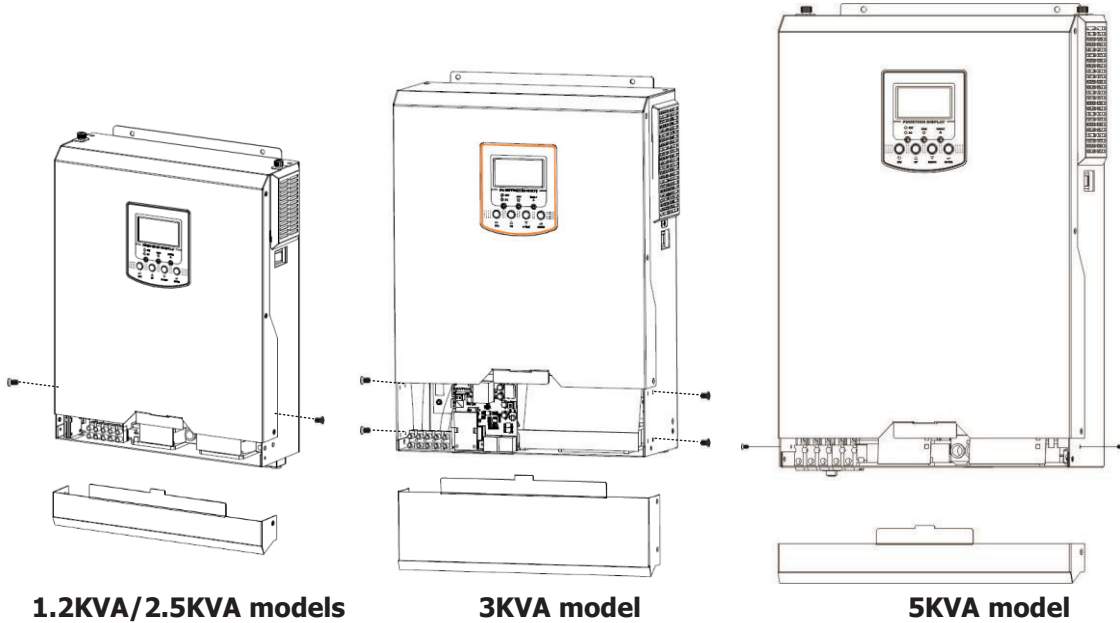

Communication Options

Serial Connection

Please use the supplied serial cable to connect between the inverter and your PC. Install the monitoring software from the bundled CD and follow the on-screen instructions to complete your installation. For detailed software operation, refer to the software user manual on the bundled CD.

Optional Wi-Fi Connection

You may purchase an optional Wi-Fi function of the unit which is equipped with a Wi-Fi transmitter. Wi-Fi transmitter can enable wireless communication between off-grid inverters and monitoring platform. Users can access and control the monitored inverter with downloaded APP. You may find "WatchPower" app from the Apple® Store or "WatchPower Wi-Fi" in Google® Play Store. All data loggers and parameters are saved in iCloud. For quick installation and operation, please check Appendix II.

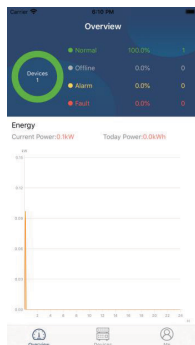

BMS Communication

It is recommended to purchase a special communication cable if you are connecting to Lithium-Ion battery banks. Please refer to Appendix B- BMS Communication Installation for details.

OPERATION

Power ON/OFF

Side view of unit

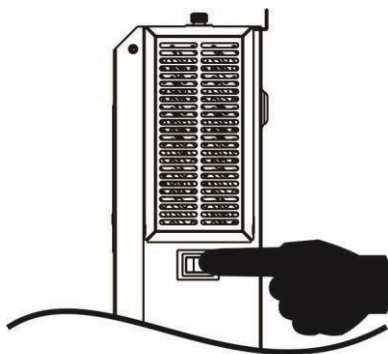

Once the unit has been properly installed and the batteries are connected well, simply press On/Off switch (located on the button of the case) to turn on the unit.

Operation and Display Panel

The operation and display panel, shown in below chart, is on the front panel of the inverter. It includes three indicators, four function keys and a LCD display, indicating the operating status and input/output power information.

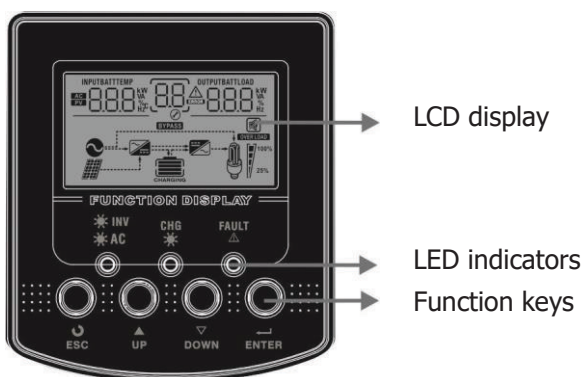

LED Indicator

| LED Indicator | | Messages | |
|---------------|-------|----------|-----------------------------------------------------|
| ☀️ AC / 🔋 INV | Green | Solid On | Output is powered by utility in Line mode. |
| | | Flashing | Output is powered by battery or PV in battery mode. |
| ☀️ CHG | Green | Solid On | Battery is fully charged. |
| | | Flashing | Battery is charging. |
| ⚠️ FAULT | Red | Solid On | Fault occurs in the inverter. |
| | | Flashing | Warning condition occurs in the inverter. |

Function Keys





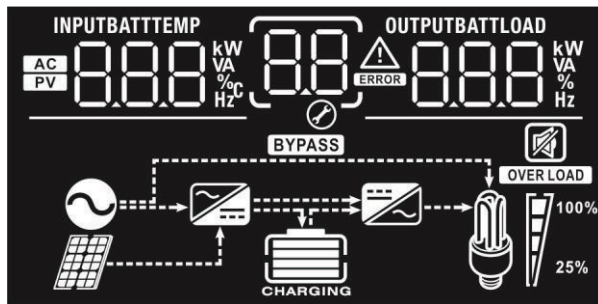



| Function Key | Description |
|--------------|----------------------------------------------------------------|
| ESC | To exit setting mode |
| UP | To go to previous selection |
| DOWN | To go to next selection |
| ENTER | To confirm the selection in setting mode or enter setting mode |

LCD Display Icons









| Icon | Function description | |
|-------------------------------------------------------------------------------------|----------------------------------------------------------------------------------------------------------------|------------------------------------------------------------------------|
| Input Source Information | | |
| AC | Indicates the AC input. | |
| PV | Indicates the PV input | |
| INPUTBATT 888 kW VA %C Hz | Indicate input voltage, input frequency, PV voltage, charger current, charger power, battery voltage. | |
| Configuration Program and Fault Information | | |
| 88 ⌚ | Indicates the setting programs. | |
| 88 ⚠️ ERROR | Indicates the warning and fault codes. | |
| | Warning: 88 ⚠️ flashing with warning code. Fault: 88 ERROR lighting with fault code | |
| Output Information | | |
| OUTPUTBATTLOAD 888 kW VA % Hz | Indicate output voltage, output frequency, load percent, load in VA, load in Watt and discharging current. | |
| Battery Information | | |
|  | Indicates battery level by 0-24%, 25-49%, 50-74% and 75-100% in battery mode and charging status in line mode. | |
| In AC mode, it will present battery charging status. | | |
| Status | Battery voltage | LCD Display |
| Constant Current mode / Constant Voltage mode | <2V/cell | 4 bars will flash in turns. |
| | 2 ~ 2.083V/cell | Bottom bar will be on and the other three bars will flash in turns. |
| | 2.083 ~ 2.167V/cell | Bottom two bars will be on and the other two bars will flash in turns. |
| Floating mode. Batteries are fully charged. | > 2.167 V/cell | Bottom three bars will be on and the top bar will flash. |
| | | 4 bars will be on. |





In battery mode, it will present battery capacity.

| Load Percentage | Battery Voltage | LCD Display |
|-----------------|---------------------------|-------------------------------------------------------------------------------------|
| Load > 50% | < 1.85V/cell |  |
| | 1.85V/cell ~ 1.933V/cell |  |
| | 1.933V/cell ~ 2.017V/cell |  |
| | > 2.017V/cell |  |
| Load < 50% | < 1.892V/cell |  |
| | 1.892V/cell ~ 1.975V/cell |  |
| | 1.975V/cell ~ 2.058V/cell |  |
| | > 2.058V/cell |  |

Load Information

| | | | | |
|-----------------------------------------------------------------------------------------------------------------------------------------------------------------------------------------|-------------------------------------------------------------------------------------|-------------------------------------------------------------------------------------|---------------------------------------------------------------------------------------|---------------------------------------------------------------------------------------|
| OVERLOAD | Indicates overload. | | | |
|   100% 25% | Indicates the load level by 0-24%, 25-49%, 50-74% and 75-100%. | | | |
| | 0%~24% | 25%~49% | 50%~74% | 75%~100% |
| |  |  |  |  |

Mode Operation Information

| | |
|-------------------------------------------------------------------------------------|---------------------------------------------------|
|  | Indicates unit connects to the mains. |
|  | Indicates unit connects to the PV panel. |
| BYPASS | Indicates load is supplied by utility power. |
|  | Indicates the utility charger circuit is working. |
|  | Indicates the DC/AC inverter circuit is working. |

Mute Operation

| | |
|-------------------------------------------------------------------------------------|-----------------------------------|
|  | Indicates unit alarm is disabled. |
|-------------------------------------------------------------------------------------|-----------------------------------|

LCD Setting

After pressing and holding ENTER button for 3 seconds, the unit will enter setting mode. Press "UP" or "DOWN" button to select setting programs. And then, press "ENTER" button to confirm the selection or ESC button to exit.

Setting Programs:









| Program | Description | Selectable option | |
|---------|---------------------------------------------------------------------------------------------------------------------------------------------------------------------------------|-------------------------------------|-----------------------------------------------------------------------------------------------------------------------------------------------------------------------------------------------------------------------------------------------------------------------------------------------------------------------------------------|
| 00 | Exit setting mode | Escape 00 ESC | |
| 01 | Output source priority: To configure load power source priority | Utility first (default) 01 UTI | Utility will provide power to the loads as first priority. Solar and battery energy will provide power to the loads only when utility power is not available. |
| | | Solar first 01 SOL | Solar energy provides power to the loads as first priority. If solar energy is not sufficient to power all connected loads, Utility energy will supply power to the loads at the same time. |
| | | SBU priority 01 SBU | Solar energy provides power to the loads as first priority. If solar energy is not sufficient to power all connected loads, battery energy will supply power to the loads at the same time. Utility provides power to the loads only when battery voltage drops to either low-level warning voltage or the setting point in program 12. |
| 02 | Maximum charging current: To configure total charging current for solar and utility chargers. (Max. charging current = utility charging current + solar charging current) | 60A (default) 02 60 ^A | Setting range is from 10A to 100A. Increment of each click is 10A. |
| 03 | AC input voltage range | Appliances (default) 03 APL | If selected, acceptable AC input voltage range will be within 90-280VAC. |
| | | UPS 03 UPS | If selected, acceptable AC input voltage range will be within 170-280VAC. |
| 05 | Battery type | AGM (default) 05 AGM | Flooded 05 FLD |



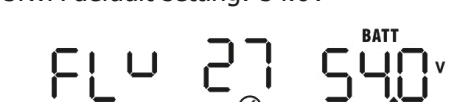

| | | | |
|----|-------------------------------------------|-------------------------------------------------|-------------------------------------------------------------------------------------------------------------------------------------------------------------------------------------------------------------------------------|
| 05 | Battery type | User-Defined 05 USE | If "User-Defined" is selected, battery charge voltage and low DC cut-off voltage can be set up in program 26, 27 and 29. |
| | | Pylontech battery 05 PYL | If selected, programs of 02, 26, 27 and 29 will be automatically set up. No need for further setting. |
| | | WECO battery 05 WEC | If selected, programs of 02, 12, 26, 27 and 29 will be auto-configured per battery supplier recommended. No need for further adjustment. |
| | | Soltaro battery 05 SOL | If selected, programs of 02, 26, 27 and 29 will be automatically set up. No need for further setting. |
| | | LIA-protocol compatible battery 05 LIA | Select "LIA" if using Lithium battery compatible to CAN protocol. If selected, programs of 02, 26, 27 and 29 will be automatically set up. No need for further setting. |
| | | LIb-protocol compatible battery 05 LIb | Select "LIb" if using Lithium battery compatible to RS485 protocol. If selected, programs of 02, 26, 27 and 29 will be automatically set up. No need for further setting. |
| | | 3 rd party Lithium battery 05 LIC | Select "LIC" if using Lithium battery not listed above. If selected, programs of 02, 26, 27 and 29 will be automatically set up. No need for further setting. Please contact the battery supplier for installation procedure. |
| 06 | Auto restart when overload occurs | Restart disable (default) 06 LFD | Restart enable 06 LFE |
| 07 | Auto restart when over temperature occurs | Restart disable (default) 07 TFD | Restart enable 07 TFE |
| 09 | Output frequency | 50Hz (default) 09 50 _{Hz} | 60Hz 09 60 _{Hz} |
| 10 | Output voltage | 220V 10 220 _v | 230V (default) 10 230 _v |

| | | | |
|----|---------------------------------------------------------------------------------------------------------------------------------------------------------------------------------------------------|----------------------------------------------------------------------------|-------------------------------------------------------------------------------------------------------------------------------------------|
| | | 240V 10 240 ^v | |
| 11 | Maximum utility charging current Note: If setting value in program 02 is smaller than that in program in 11, the inverter will apply charging current from program 02 for utility charger. | Available options in 1.2K/2.5K/3KVA models | |
| | | 40A (default) 11 40 ^A | Setting range is 2A, then from 10A to 80A. Increment of each click is 10A. |
| | | Available options in 5KVA model: | |
| | | 30A (default) 11 30 ^A | Setting range is 2A, then from 10A to 100A. Increment of each click is 10A. |
| 12 | Setting voltage point back to utility source when selecting "SBU priority" or "Solar first" in program 01. | Available options in 1.2KVA model: | |
| | | 11.0V 12 BATT 110 ^v | 11.3V 12 BATT 113 ^v |
| | | 11.5V (default) 12 BATT 115 ^v | 11.8V 12 BATT 118 ^v |
| | | 12.0V 12 BATT 120 ^v | 12.3V 12 BATT 123 ^v |
| | | 12.5V 12 BATT 125 ^v | 12.8V 12 BATT 128 ^v |
| | | Available options in 2.5KVA/3KVA model: | |
| | | 23.0V (default) 12 BATT 230 ^v | Setting range is from 22V to 25.5V. Increment of each click is 0.5V. |
| | | Available options in 5KVA model: | |
| | | 46V (default) 12 BATT 46 ^v | Setting range is from 44V to 51V. Increment of each click is 1V. |
| | | Available options when any lithium battery type is selected in Program 05. | |
| | | SOC 10% (default for Lithium) 12 BATT 10 [%] | If any types of lithium battery is selected in program 05, setting value will change to SOC automatically. Adjustable range is 5% to 95%. |

| | | | |
|----|----------------------------------------------------------------------------------------------------------|-----------------------------------------------------------------------------------------------------------------------|----------------------------------------------------------------------------------------------------------------------------------------------------------------------------|
| 13 | Setting voltage point back to battery mode when selecting "SBU priority" or "Solar first" in program 01. | Available options in 1.2KVA model: | |
| | | Battery fully charged 13 ^{BATT} FUL | 12.0V 13 ^{BATT} 12.0 ^v |
| | | 12.3V 13 ^{BATT} 12.3 ^v | 12.5V 13 ^{BATT} 12.5 ^v |
| | | 12.8V 13 ^{BATT} 12.8 ^v | 13.0V 13 ^{BATT} 13.0 ^v |
| | | 13.3V 13 ^{BATT} 13.3 ^v | 13.5V (default) 13 ^{BATT} 13.5 ^v |
| | | 13.8V 13 ^{BATT} 13.8 ^v | 14.0V 13 ^{BATT} 14.0 ^v |
| | | 14.3V 13 ^{BATT} 14.3 ^v | 14.5V 13 ^{BATT} 14.5 ^v |
| | | Available options in 2.5KVA/3KVA model: Setting range is FUL and from 24V to 29V. Increment of each click is 0.5V. | |
| | | Battery fully charged 13 ^{BATT} FUL | 27V (default) 13 ^{BATT} 27.0 ^v |
| | | Available options in 5KVA model: Setting range is FUL and from 48V to 58V. Increment of each click is 1V. | |
| | | Battery fully charged 13 ^{BATT} FUL | 54V (default) 13 ^{BATT} 54.0 ^v |
| | | Available option when any lithium battery type is selected in Program 05. | |
| | | SOC 80% (default for Lithium) 13 ^{BATT} 80% | If any types of lithium battery is selected in program 05, setting value will change to SOC automatically. Adjustable range is 10% to 100%. Increment of each click is 5%. |

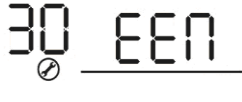
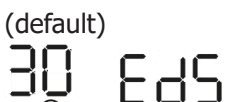
| | | | |
|---------------------------------------------------------------------------------------------------------------------------------------------------------------|-----------------------------------------------------------------------------------------------------------|----------------------------------------------------------------------------------------------------------------|-----------------------------------------------------------------------------------------------------------------------------------------------------------------------------------------|
| 16 | Charger source priority: To configure charger source priority | If this inverter/charger is working in Line, Standby or Fault mode, charger source can be programmed as below: | |
| | | Solar first 16 C50 | Solar energy will charge battery as first priority. Utility will charge battery only when solar energy is not available. |
| | | Solar and Utility (default) 16 5NU | Solar energy and utility will charge battery at the same time. |
| | | Only Solar 16 050 | Solar energy will be the only charger source no matter utility is available or not. |
| If this inverter/charger is working in Battery mode, only solar energy can charge battery. Solar energy will charge battery if it's available and sufficient. | | | |
| 18 | Alarm control | Alarm on (default) 18 60N | Alarm off 18 60F |
| 19 | Auto return to default display screen | Return to default display screen (default) 19 ESP | If selected, no matter how users switch display screen, it will automatically return to default display screen (Input voltage /output voltage) after no button is pressed for 1 minute. |
| | | Stay at latest screen 19 LEP | If selected, the display screen will stay at latest screen user finally switches. |
| 20 | Backlight control | Backlight on (default) 20 LON | Backlight off 20 LOF |
| 22 | Beeps while primary source is interrupted | Alarm on (default) 22 AON | Alarm off 22 AOF |
| 23 | Overload bypass: When enabled, the unit will transfer to line mode if overload occurs in battery mode. | Bypass disable (default) 23 byd | Bypass enable 23 byE |
| 25 | Record Fault code | Record enable (default) 25 FEN | Record disable 25 FdS |
| 26 | Bulk charging voltage (C.V voltage) | 1.2KVA default setting: 14.1V CU 26 BATT 14.1V | |

| | | |
|----|----------------------------------------|----------------------------------------------------------------------------------------------------------------------------------------------------------------------------------------------------------------------------------------------------------------------------------------------------------------------------------------------|
| 26 | Bulk charging voltage (C.V voltage) | 2.5KVA/3KVA default setting: 28.2V  |
| | | 5KVA default setting: 56.4V  |
| | | If self-defined is selected in program 5, this program can be set up. Setting range is from 12.5V to 15.0V for 1.2KVA model, 25.0V to 31.0V for 2.5KVA/3KVA model and 48.0V to 61.0V for 5KVA model. Increment of each click is 0.1V. |
| 27 | Floating charging voltage | 1.2KVA default setting: 13.5V  |
| | | 2.5KVA/3KVA default setting: 27.0V  |
| | | 5KVA default setting: 54.0V  |
| | | If self-defined is selected in program 5, this program can be set up. Setting range is from 12.5V to 15.0V for 1.2KVA model, 25.0V to 31.0V for 2.5KVA/3KVA models and 48.0V to 61.0V for 5KVA model. Increment of each click is 0.1V. |
| 29 | Low DC cut-off voltage | 1.2KVA default setting: 10.5V  |
| | | 2.5KVA/3KVA default setting: 21.0V  |
| | | 5KVA default setting: 42.0V  |
| | | If self-defined is selected in program 5, this program can be set up. Setting range is from 10.5V to 12.0V for 1.2KVA model, 21.0V to 24.0V for 2.5KVA/3KVA models and 42.0V to 48.0V for 5KVA model. Increment of each click is 0.1V. Low DC cut-off voltage will be fixed to setting value no matter what percentage of load is connected. |

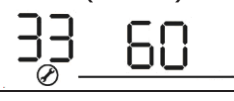
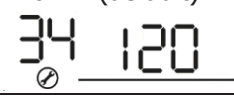
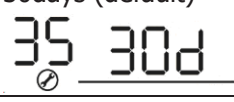
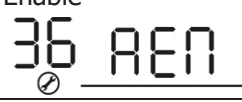
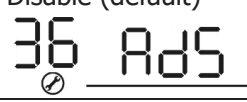
| | | | |
|----|------------------------------------|----------------------------------------------------------------------------------------------------------------------------------------------------------------------------------------------------------------------------------------------------------------------------------------------------------------------------------------------------------------------------------------------------------------|----------------------------------------------------------------------------------------------------------------------------------|
| 29 | Low DC cut-off voltage | lithium battery default setting: SOC 5%  | |
| | | If any type of lithium battery is selected in program 05, setting value will change to SOC automatically. Adjustable range is 0% to 90%. Increment of each click is 1%. | |
| 30 | Battery equalization | Battery equalization  | Battery equalization disable (default)  |
| | | If "Flooded" or "User-Defined" is selected in program 05, this program can be set up. | |
| 31 | Battery equalization voltage | 1.2KVA default setting: 14.6V  | |
| | | 2.5KVA/3KVA default setting: 29.2V  | |
| | | 5KVA default setting: 58.4V  | |
| | | Setting range is from 12.0V to 15.0V for 1.2KVA model, 25.0V to 31.0V for 2.5KVA/3KVA models and 48.0V to 61.0V for 5KVA model. Increment of each click is 0.1V. | |
| 33 | Battery equalized time | 60min (default)  | Setting range is from 5min to 900min. Increment of each click is 5min. |
| 34 | Battery equalized timeout | 120min (default)  | Setting range is from 5min to 900 min. Increment of each click is 5 min. |
| 35 | Equalization interval | 30days (default)  | Setting range is from 0 to 90 days. Increment of each click is 1 day |
| 36 | Equalization activated immediately | Enable  | Disable (default)  |
| | | If equalization function is enabled in program 30, this program can be set up. If "Enable" is selected in this program, it's to activate battery equalization immediately and LCD main page will shows "E9". If "Disable" is selected, it will cancel equalization function until next activated equalization time arrives based on program 35 setting. At this time, "E9" will not be shown in LCD main page. | |

Display Setting

The LCD display information will be switched in turns by pressing "UP" or "DOWN" key. The selectable information is switched as following order in listed table.

| Selectable information | LCD display |
|----------------------------------------------------------|---------------------------------------------|
| Input voltage/Output voltage (Default Display Screen) | Input Voltage=230V, output voltage=230V |
| Input frequency | Input frequency=50Hz |
| PV voltage | PV voltage=260V |
| PV current | PV current = 2.5A |
| PV power | PV power = 500W |

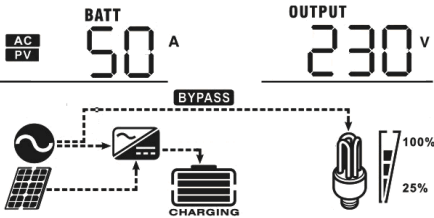
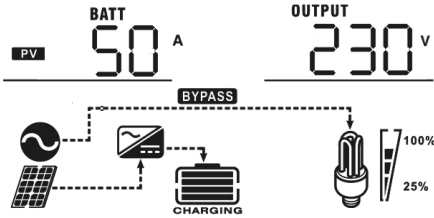
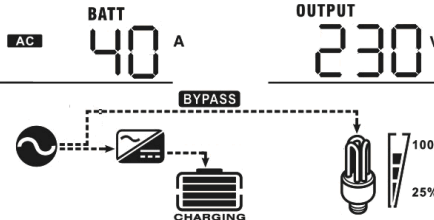
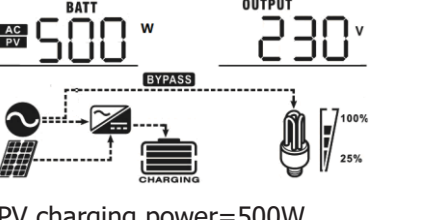
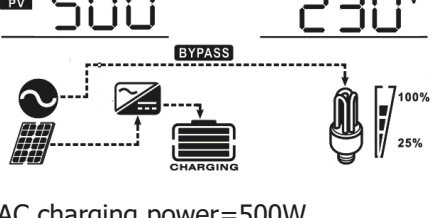
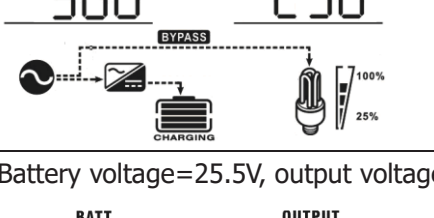
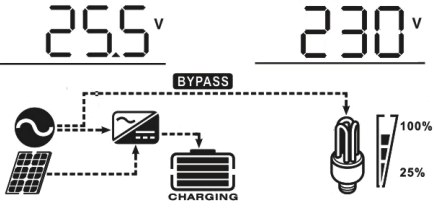

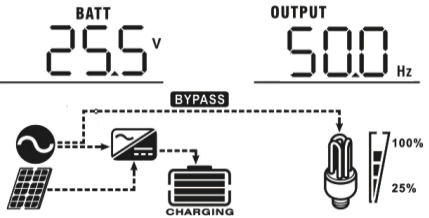
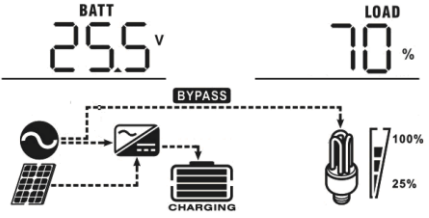
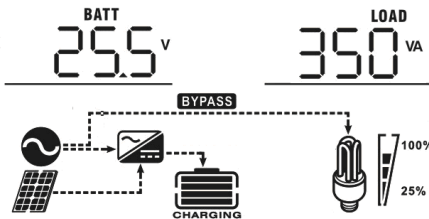
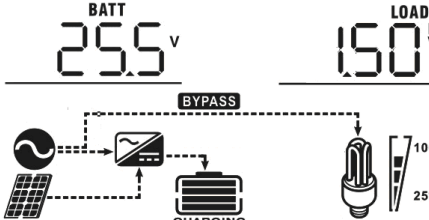
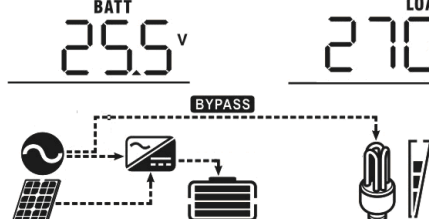
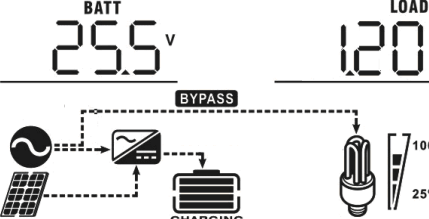
| | |
|------------------------------------|-----------------------------------------------------------------------------------------------------------------------------------------------------------------------------------------------------------------------------------------------------------------------------------------------------------------------------------------------------------------|
| Charging current | <p>AC and PV charging current=50A</p>  <p>PV charging current=50A</p>  <p>AC charging current=40A</p>  |
| Charging power | <p>AC and PV charging power=500W</p>  <p>PV charging power=500W</p>  <p>AC charging power=500W</p>  |
| Battery voltage and output voltage | <p>Battery voltage=25.5V, output voltage=230V</p>  |



| | |
|-------------------------|-----------------------------------------------------------------------------------------------------------------------------------------------------------------------------------------------------------------------------------------------------------------------------------------------------------------------------------------------------------------------|
| <p>Output frequency</p> | <p>Output frequency=50Hz</p>  |
| <p>Load percentage</p> | <p>Load percent=70%</p>  |
| <p>Load in VA</p> | <p>When connected load is lower than 1kVA, load in VA will present xxxVA like below chart.</p>  <p>When load is larger than 1kVA (1kVA), load in VA will present x.xkVA like below chart.</p>  |
| <p>Load in Watt</p> | <p>When load is lower than 1kW, load in W will present xxxW like below chart.</p>  <p>When load is larger than 1kW (1kW), load in W will present x.xkW like below chart.</p>  |

| | |
|----------------------------------------|------------------------------------------------------|
| Battery voltage/DC discharging current | <p>Battery voltage=25.5V, discharging current=1A</p> |
| Main CPU version checking | <p>Main CPU version 00014.04</p> |
| Secondary CPU version checking. | <p>Secondary CPU version 00001.00</p> |

Operating Mode Description

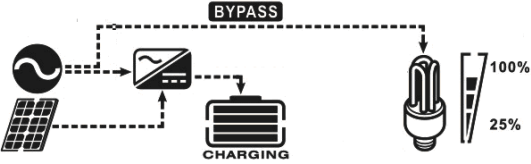
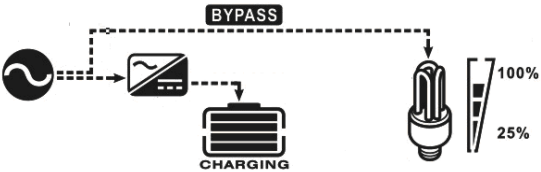
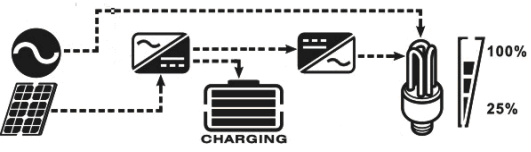
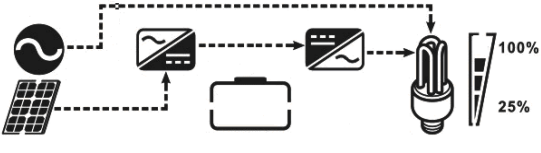
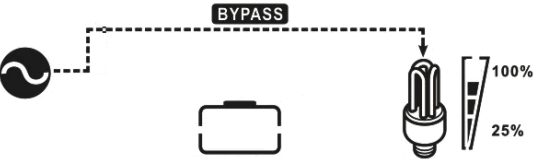
| Operation mode | Description | LCD display |
|------------------------------------------------------------------------------------------------------------------------------------------------------------------------------|-----------------------------------------------------------------------------|-------------------------------------------|
| <p>Standby mode</p> <p>Note:</p> <p>*Standby mode: The inverter is not turned on yet but at this time, the inverter can charge battery without AC output.</p> | <p>No output is supplied by the unit but it still can charge batteries.</p> | <p>Charging by utility and PV energy.</p> |
| | | <p>Charging by utility.</p> |
| | | <p>Charging by PV energy.</p> |
| | | <p>No charging.</p> |
| <p>Fault mode</p> <p>Note:</p> <p>*Fault mode: Errors are caused by inside circuit error or external reasons such as over temperature, output short circuited and so on.</p> | <p>PV energy and utility can charge batteries.</p> | <p>Charging by utility and PV energy.</p> |
| | | <p>Charging by utility.</p> |

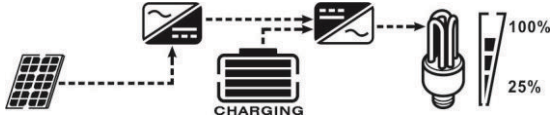
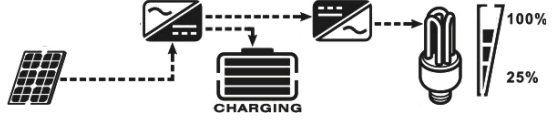
| | | |
|------------------|---------------------------------------------------------------------------------------------------------|---------------------------------------------------------------------------------------------------------------------------------------------------------------------------------------------------------------------------------------------------------------------------------------------------------|
| | | <p>Charging by PV energy.</p>  |
| <p>Line Mode</p> | <p>The unit will provide output power from the mains. It will also charge the battery at line mode.</p> | <p>No charging.</p>  |
| | | <p>Charging by utility and PV energy.</p>  |
| | <p>The unit will provide output power from the mains. It will also charge the battery at line mode.</p> | <p>Charging by utility.</p>  |
| | | <p>If "solar first" is selected as output source priority and solar energy is not sufficient to provide the load, solar energy and the utility will provide the loads and charge the battery at the same time.</p>  |
| | | <p>If "solar first" is selected as output source priority and battery is not connected, solar energy and the utility will provide the loads.</p>  |
| | | <p>Power from utility.</p>  |

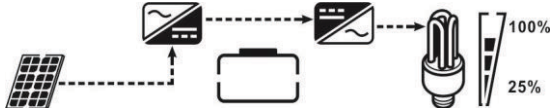
| Operation mode | Description | LCD display |
|----------------|---------------------------------------------------------------|---------------------------------------------------------------------------------------------------------------------------------------------------------------------|
| Battery Mode | The unit will provide output power from battery and PV power. | Power from battery and PV energy.  |
| | | PV energy will supply power to the loads and charge battery at the same time.  |
| | | Power from battery only.  |
| | | Power from PV energy only.  |

Battery Equalization Description

Equalization function is added into charge controller. It reverses the buildup of negative chemical effects like stratification, a condition where acid concentration is greater at the bottom of the battery than at the top. Equalization also helps to remove sulfate crystals that might have built up on the plates. If left unchecked, this condition, called sulfation, will reduce the overall capacity of the battery. Therefore, it's recommended to equalize battery periodically.

- **How to Apply Equalization Function**

You must enable battery equalization function in monitoring LCD setting program 30 first. Then, you may apply this function in device by either one of following methods:

1. Setting equalization interval in program 35.
2. Active equalization immediately in program 36.

- **When to Equalize**

In float stage, when the setting equalization interval (battery equalization cycle) is arrived, or equalization is active immediately, the controller will start to enter Equalize stage.

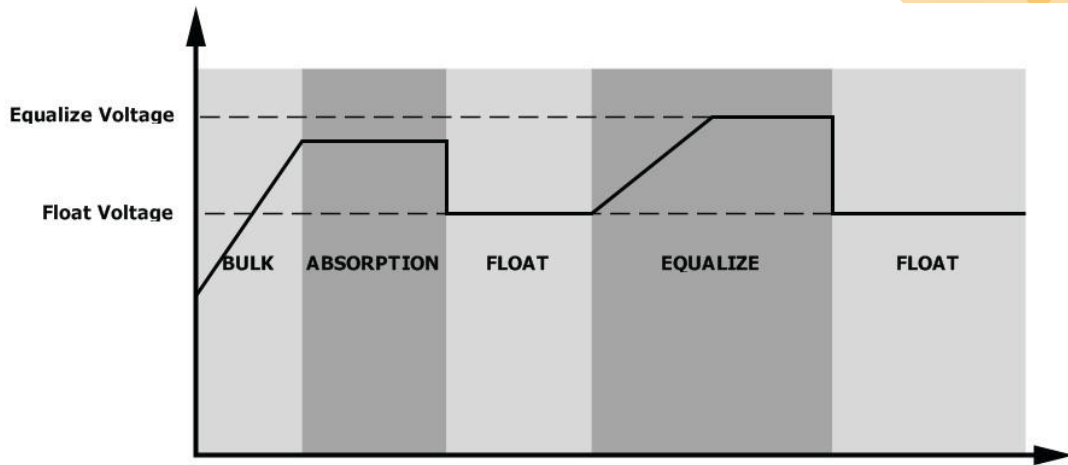

- **Equalize charging time and timeout**



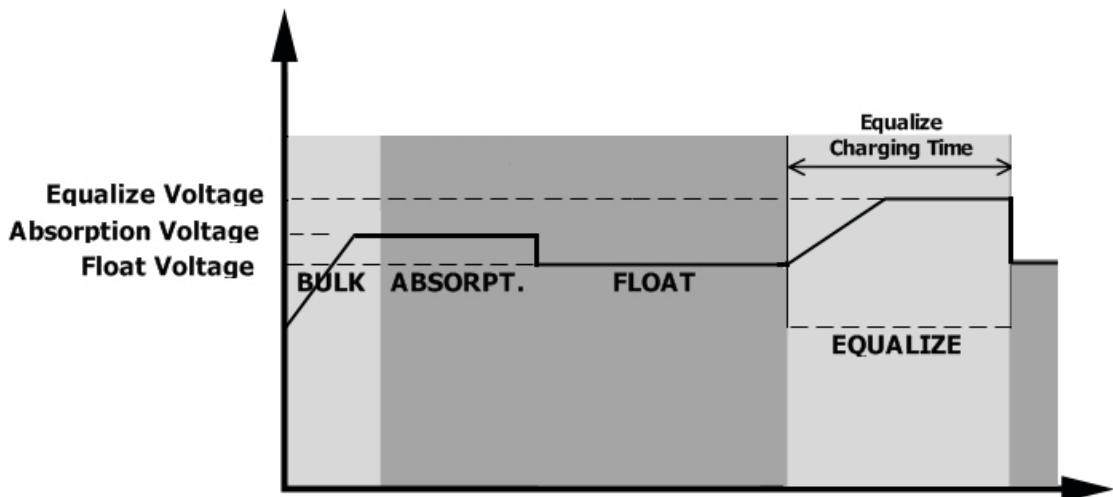



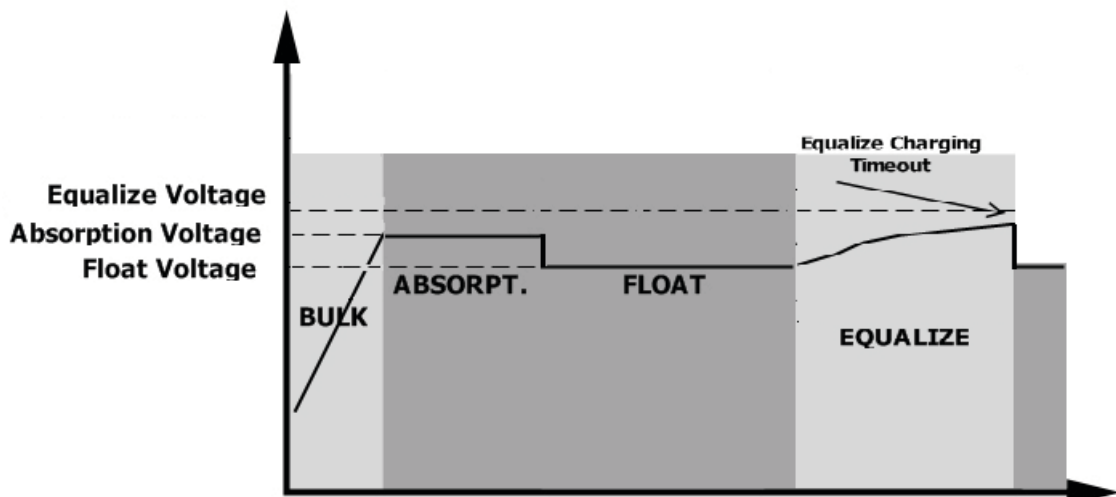









In Equalize stage, the controller will supply power to charge battery as much as possible until battery voltage raises to battery equalization voltage. Then, constant-voltage regulation is applied to maintain battery voltage at the battery equalization voltage. The battery will remain in the Equalize stage until setting battery equalized time is arrived.











However, in Equalize stage, when battery equalized time is expired and battery voltage doesn't rise to battery equalization voltage point, the charge controller will extend the battery equalized time until battery voltage achieves battery equalization voltage. If battery voltage is still lower than battery equalization voltage when battery equalized timeout setting is over, the charge controller will stop equalization and return to float stage.



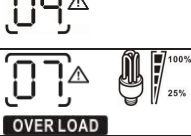

Fault Reference Code

| Fault Code | Fault Event | Icon on |
|------------|------------------------------------------------------------------------------------------|---------------------------------------------------------------------------------------|
| 01 | Fan is locked when inverter is off. |  |
| 02 | Over temperature or NTC is not connected well. |  |
| 03 | Battery voltage is too high |  |
| 04 | Battery voltage is too low |  |
| 05 | Output short circuited or over temperature is detected by internal converter components. |  |
| 06 | Output voltage is too high. |  |
| 07 | Overload time out |  |
| 08 | Bus voltage is too high |  |
| 09 | Bus soft start failed |  |
| 51 | Over current or surge |  |
| 52 | Bus voltage is too low |  |
| 53 | Inverter soft start failed |  |
| 55 | Over DC voltage in AC output |  |
| 57 | Current sensor failed |  |
| 58 | Output voltage is too low |  |
| 59 | PV voltage is over limitation |  |

Warning Indicator

| Warning Code | Warning Event | Audible Alarm | Icon flashing |
|--------------|----------------------------------------------------------------|-------------------------------|---------------------------------------------------------------------------------------|
| 01 | Fan is locked when inverter is on. | Beep three times every second |  |
| 02 | Over temperature | None |  |
| 03 | Battery is over-charged | Beep once every second |  |
| 04 | Low battery | Beep once every second |  |
| 07 | Overload | Beep once every 0.5 second |  |
| 10 | Output power derating | Beep twice every 3 seconds |  |
| 15 | PV energy is low. | Beep twice every 3 seconds |  |
| 16 | High AC input (>280VAC) during BUS soft start | None |  |
| 32 | Communication failure between inverter and communication board | None |  |

| | | | |
|----|--------------------------|------|-------------------------------------------------------------------------------------|
| E9 | Battery equalization | None |  |
| bP | Battery is not connected | None |  |

CLEARANCE AND MAINTENANCE FOR ANTI-DUST KIT

Overview

Every inverter is already installed with anti-dusk kit from factory. This kit keeps dusk from your inverter and increases product reliability in harsh environment.

Clearance and Maintenance

Step 1: Please loosen the screw in counterclockwise direction on the top of the inverter.

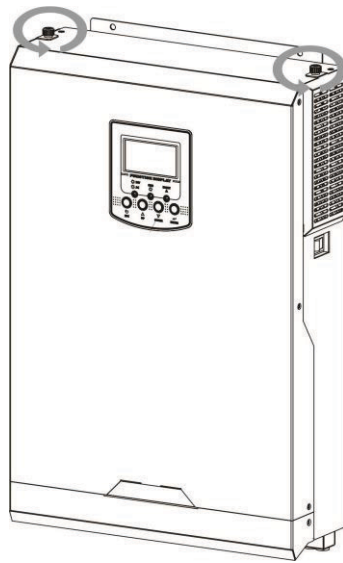

Step 2: Then, dustproof case can be removed and take out air filter foam as shown in below chart.

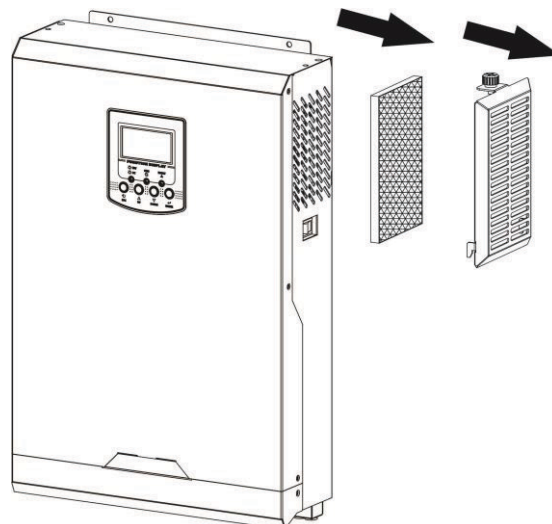

Step 3: Clean air filter foam and dustproof case. After clearance, re-assemble the dust-kit back to the inverter.

NOTICE: The anti-dust kit should be cleaned from dust every one month.

SPECIFICATIONS

Table 1 Line Mode Specifications

| INVERTER MODEL | 1.2KVA | 2.5KVA | 3KVA | 5KVA |
|---------------------------------------------------------------------------------------------------------------------|---------------------------------------------------------------------------------------------------------------------------------------------------------------------------------------------------------------------------------------------------------------------------------------------------------------------------------------------------------------------------------------------------------------------------------------------------------------------------------------------------|--------|------|------|
| Input Voltage Waveform | Sinusoidal (utility or generator) | | | |
| Nominal Input Voltage | 230Vac | | | |
| Low Loss Voltage | 170Vac±7V (UPS); 90Vac±7V (Appliances) | | | |
| Low Loss Return Voltage | 180Vac±7V (UPS); 100Vac±7V (Appliances) | | | |
| High Loss Voltage | 280Vac±7V | | | |
| High Loss Return Voltage | 270Vac±7V | | | |
| Max AC Input Voltage | 300Vac | | | |
| Nominal Input Frequency | 50Hz / 60Hz (Auto detection) | | | |
| Low Loss Frequency | 40±1Hz | | | |
| Low Loss Return Frequency | 42±1Hz | | | |
| High Loss Frequency | 65±1Hz | | | |
| High Loss Return Frequency | 63±1Hz | | | |
| Output Short Circuit Protection | Circuit Breaker | | | |
| Efficiency (Line Mode) | >95% (Rated R load, battery full charged) | | | |
| Transfer Time | 10ms typical (UPS); 20ms typical (Appliances) | | | |
| <p>Output power derating: When AC input voltage drops to 170V, the output power will be derated.</p> | <p>The graph illustrates the output power derating characteristic. The vertical axis represents Output Power, with a horizontal dotted line for Rated Power and a lower horizontal dotted line for 50% Power. The horizontal axis represents Input Voltage, with markers at 90V, 170V, and 280V. The power remains constant at the Rated Power level from 170V up to 280V. Between 170V and 90V, the power decreases linearly to 50% of the Rated Power. Below 90V, the output power is zero.</p> | | | |

Table 2 Inverter Mode Specifications

| INVERTER MODEL | 1.2KVA | 2. 5KVA | 3KVA | 5KVA |
|------------------------------------------------------|-----------------------------------|---------------|----------|----------|
| Rated Output Power | 1.2KVA/ 1.2KW | 2.5KVA/ 2.5KW | 3KVA/3KW | 5KVA/5KW |
| Output Voltage Waveform | Pure Sine Wave | | | |
| Output Voltage Regulation | 230Vac±5% | | | |
| Output Frequency | 50Hz | | | |
| Peak Efficiency | 93% | | | |
| Overload Protection | 5s@≥130% load; 10s@105%~130% load | | | |
| Surge Capacity | 2* rated power for 5 seconds | | | |
| Nominal DC Input Voltage | 12Vdc | 24Vdc | | 48Vdc |
| Cold Start Voltage | 11.5Vdc | 23.0Vdc | | 46.0Vdc |
| Low DC Warning Voltage @ load < 50% | 11.5Vdc | 23.0Vdc | | 46.0Vdc |
| @ load ≥ 50% | 11.0Vdc | 22.0Vdc | | 44.0Vdc |
| Low DC Warning Return Voltage @ load < 50% | 11.7Vdc | 23.5Vdc | | 47.0Vdc |
| @ load ≥ 50% | 11.5Vdc | 23.0Vdc | | 46.0Vdc |
| Low DC Cut-off Voltage @ load < 50% | 10.7Vdc | 21.5Vdc | | 43.0Vdc |
| @ load ≥ 50% | 10.5Vdc | 21.0Vdc | | 42.0Vdc |
| High DC Recovery Voltage | 15Vdc | 31Vdc | | 62Vdc |
| High DC Cut-off Voltage | 16Vdc | 32Vdc | | 63Vdc |
| No Load Power Consumption | <35W | | | <50W |

Table 3 Charge Mode Specifications

| Utility Charging Mode | | | | |
|------------------------------------------------------|--------------------------------|-----------|-------|------------------|
| INVERTER MODEL | 1.2KVA | 2.5KVA | 3KVA | 5KVA |
| Charging Algorithm | 3-Step | | | |
| AC Charging Current (Max) | 80Amp (@ $V_{I/P}=230V_{ac}$) | | | 100Amp |
| Bulk Charging Voltage | Flooded Battery | 14.6 | 29.2 | 58.4 |
| | AGM / Gel Battery | 14.1 | 28.2 | 56.4 |
| Floating Charging Voltage | 13.5Vdc | 27Vdc | 54Vdc | |
| Charging Curve | | | | |
| MPPT Solar Charging Mode | | | | |
| INVERTER MODEL | 1.2KVA | 2.5KVA | 3KVA | 5KVA |
| Max. PV Array Power | 2000W | 3000W | | 5000W |
| Nominal PV Voltage | 240Vdc | | | 320Vdc |
| Start-up Voltage | 70Vdc +/- 10Vdc | | | 150Vdc +/- 10Vdc |
| PV Array MPPT Voltage Range | 60~300Vdc | 60~400Vdc | | 120~450Vdc |
| Max. PV Array Open Circuit Voltage | 350Vdc | 450Vdc | | 500Vdc |
| Max. Input Current | 13Amp | | | 18Amp |
| Max Charging Current (AC charger plus solar charger) | 100Amp | | | |

Table 4 General Specifications

| INVERTER MODEL | 1.2KVA | 2.5KVA | 3KVA | 5KVA |
|-----------------------------|----------------------------------------------|-----------------|-----------------|------|
| Safety Certification | CE | | | |
| Operating Temperature Range | -10°C to 50°C | | | |
| Storage temperature | -15°C~ 60°C | | | |
| Humidity | 5% to 95% Relative Humidity (Non-condensing) | | | |
| Dimension (D*W*H), mm | 90 x 288 x 357 | 110 x 288 x 390 | 120 x 300 x 440 | |
| Net Weight, kg | 6.5 | 7.0 | 7.2 | 10 |

TROUBLE SHOOTING

| Problem | LCD/LED/Buzzer | Explanation / Possible cause | What to do |
|-------------------------------------------------------------------------------|-------------------------------------------------------------------------|-----------------------------------------------------------------------------------------------------------------------------------------------------------------------------------|------------------------------------------------------------------------------------------------------------------------------------------------------------------------|
| Unit shuts down automatically during startup process. | LCD/LEDs and buzzer will be active for 3 seconds and then complete off. | The battery voltage is too low (<1.91V/Cell) | 1. Re-charge battery. 2. Replace battery. |
| No response after power on. | No indication. | 1. The battery voltage is far too low. (<1.4V/Cell) 2. Internal fuse tripped. | 1. Contact repair center for replacing the fuse. 2. Re-charge battery. 3. Replace battery. |
| Mains exist but the unit works in battery mode. | Input voltage is displayed as 0 on the LCD and green LED is flashing. | Input protector is tripped | Check if AC breaker is tripped and AC wiring is connected well. |
| | Green LED is flashing. | Insufficient quality of AC power. (Shore or Generator) | 1. Check if AC wires are too thin and/or too long. 2. Check if generator (if applied) is working well or if input voltage range setting is correct. (UPS→Appliance) |
| | Green LED is flashing. | Set "Solar First" as the priority of output source. | Change output source priority to Utility first. |
| When the unit is turned on, internal relay is switched on and off repeatedly. | LCD display and LEDs are flashing | Battery is disconnected. | Check if battery wires are connected well. |
| Buzzer beeps continuously and red LED is on. | Fault code 07 | Overload error. The inverter is overload 105% and time is up. | Reduce the connected load by switching off some equipment. |
| | | If PV input voltage is higher than specification, the output power will be derated. At this time, if connected loads is higher than derated output power, it will cause overload. | Reduce the number of PV modules in series or the connected load. |
| | Fault code 05 | Output short circuited. | Check if wiring is connected well and remove abnormal load. |
| | | Temperature of internal converter component is over 120°C. | Check whether the air flow of the unit is blocked or whether the ambient temperature is too high. |
| | Fault code 02 | Internal temperature of inverter component is over 100°C. | Return to repair center. |
| | Fault code 03 | Battery is over-charged. | Return to repair center. |
| | | The battery voltage is too high. | Check if spec and quantity of batteries are meet requirements. |
| | Fault code 01 | Fan fault | Replace the fan. |
| | Fault code 06/58 | Output abnormal (Inverter voltage below than 190Vac or is higher than 260Vac) | 1. Reduce the connected load. 2. Return to repair center |
| | Fault code 08/09/53/57 | Internal components failed. | Return to repair center. |
| | Fault code 51 | Over current or surge. | Restart the unit, if the error happens again, please return to repair center. |
| | Fault code 52 | Bus voltage is too low. | |
| Fault code 55 | Output voltage is unbalanced. | | |
| Fault code 59 | PV input voltage is beyond the specification. | Reduce the number of PV modules in series. | |

Appendix I: BMS Communication Installation

1. Introduction

If connecting to lithium battery, it is recommended to purchase a custom-made RJ45 communication cable. Please check with your dealer or integrator for details.

This custom-made RJ45 communication cable delivers information and signal between lithium battery and the inverter. These information are listed below:

- Re-configure charging voltage, charging current and battery discharge cut-off voltage according to the lithium battery parameters.
- Have the inverter start or stop charging according to the status of lithium battery.

2. Pin Assignment for BMS Communication Port

| | Definition |
|-------|------------|
| PIN 1 | RS232TX |
| PIN 2 | RS232RX |
| PIN 3 | RS485B |
| PIN 4 | NC |
| PIN 5 | RS485A |
| PIN 6 | CANH |
| PIN 7 | CANL |
| PIN 8 | GND |

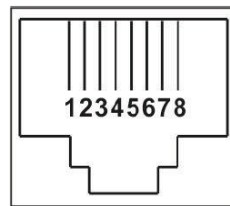

3. Lithium Battery Communication Configuration

LIO-4805/LIO-4810-150A

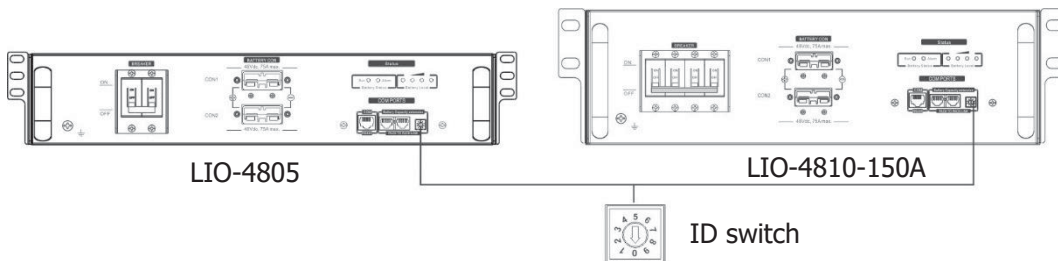

LIO II-4810

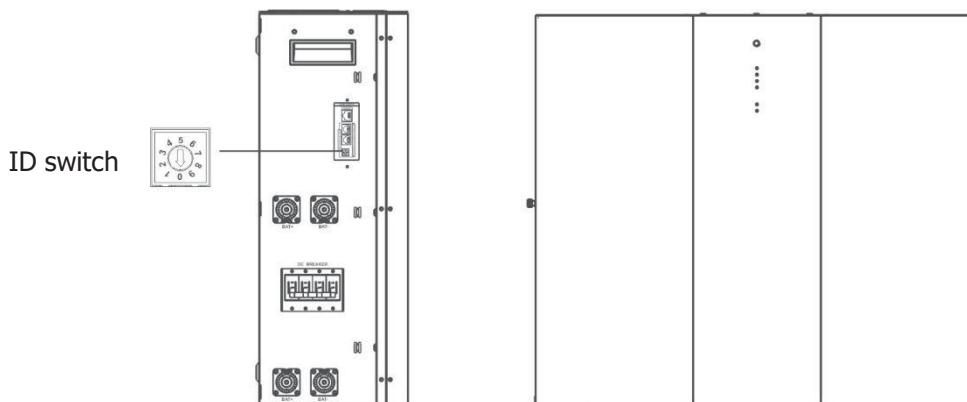

ID Switch indicates the unique ID code for each battery module. It's required to assign an identical ID to each battery module for normal operation. We can set up the ID code for each battery module by rotating the PIN number on the ID switch. From number 0 to 9, the number can be random; no particular order. Maximum 10 battery modules can be operated in parallel.

PYLONTECH

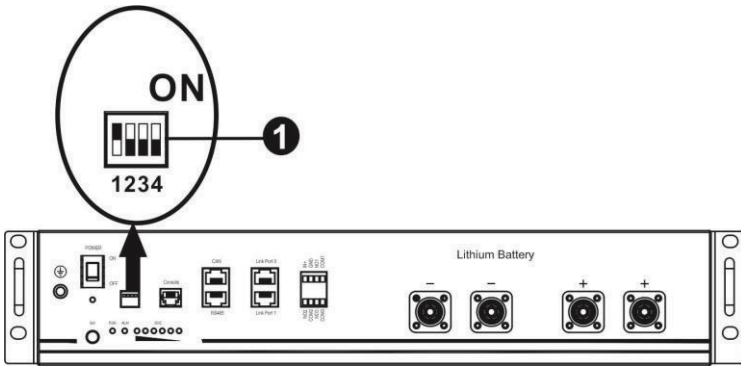

① Dip Switch: There are 4 Dip Switches that sets different baud rate and battery group address. If switch position is turned to the "OFF" position, it means "0". If switch position is turned to the "ON" position, it means "1".

Dip 1 is "ON" to represent the baud rate 9600.

Dip 2, 3 and 4 are reserved for battery group address.

Dip switch 2, 3 and 4 on master battery (first battery) are to set up or change the group address.

NOTE: "1" is upper position and "0" is bottom position.

| Dip 1 | Dip 2 | Dip 3 | Dip 4 | Group address |
|-----------------------------------------------------------------|-------|-------|-------|----------------------------------------------------------------------------------------------------------------------------------------------|
| 1: RS485 baud rate=9600 Restart to take effect | 0 | 0 | 0 | Single group only. It's required to set up master battery with this setting and slave batteries are unrestricted. |
| | 1 | 0 | 0 | Multiple group condition. It's required to set up master battery on the first group with this setting and slave batteries are unrestricted. |
| | 0 | 1 | 0 | Multiple group condition. It's required to set up master battery on the second group with this setting and slave batteries are unrestricted. |
| | 1 | 1 | 0 | Multiple group condition. It's required to set up master battery on the third group with this setting and slave batteries are unrestricted. |
| | 0 | 0 | 1 | Multiple group condition. It's required to set up master battery on the fourth group with this setting and slave batteries are unrestricted. |
| | 1 | 0 | 1 | Multiple group condition. It's required to set up master battery on the fifth group with this setting and slave batteries are unrestricted. |

NOTE: The maximum groups of lithium battery is 5 and for maximum number for each group, please check with battery manufacturer.

4. Installation and Operation

LIO-4805/LIO-4810-150A/ESS LIO II-4810

After ID no. is assigned for each battery module, please set up LCD panel in inverter and install the wiring connection as following steps.

Step 1: Use supplied RJ11 signal cable to connect into the extension port (P1 or P2).

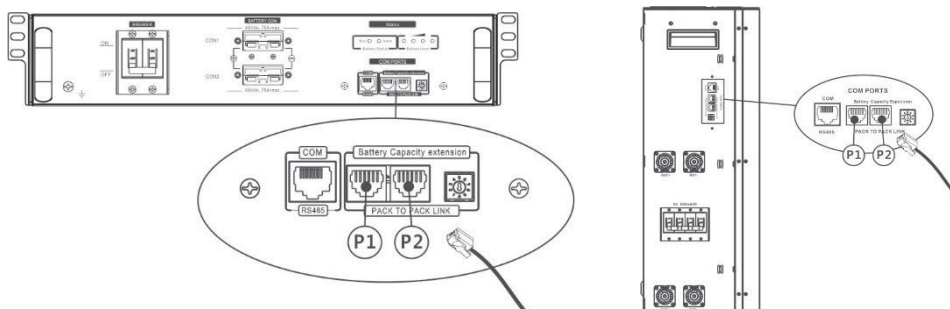

Step 2: Use supplied RJ45 cable (from battery module package) to connect inverter and Lithium battery.

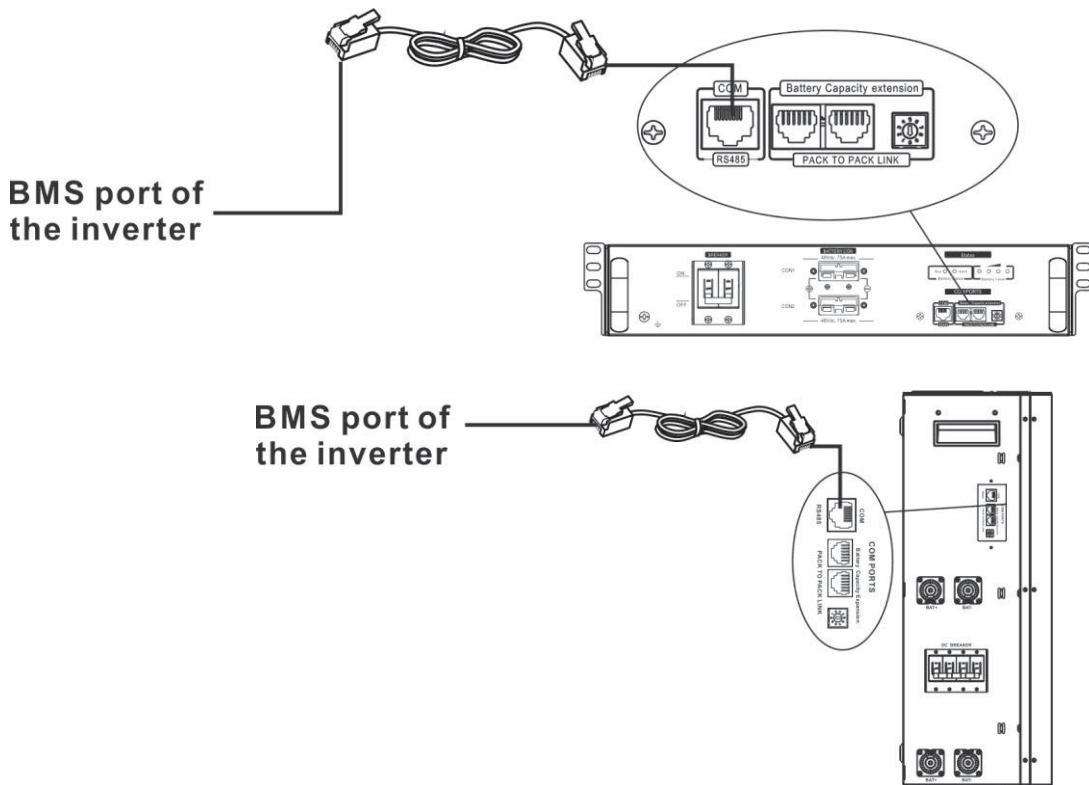

Note for parallel system:

1. Only support common battery installation.
2. Use custom-made RJ45 cable to connect any inverter (no need to connect to a specific inverter) and Lithium battery. Simply set this inverter battery type to "LIB" in LCD program 5. Others should be "USE".

Step 3: Turn the breaker switch "ON". Now, the battery module is ready for DC output.

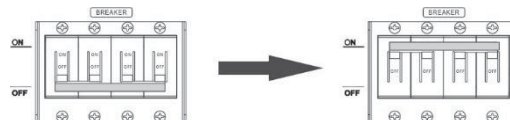

Step 4: Press Power on/off button on battery module for 5 secs, the battery module will start up.

*If the manual button cannot be approached, just simply turn on the inverter module. The battery module will be automatically turned on.

Step 5. Turn on the inverter.

Step 6. Be sure to select battery type as "LIB" in LCD program 5.



If communication between the inverter and battery is successful, the battery icon  on LCD display will flash. Generally speaking, it will take longer than 1 minute to establish communication.

PYLONTECH

After configuration, please install LCD panel with inverter and Lithium battery with the following steps.

Step 1. Use custom-made RJ45 cable to connect inverter and Lithium battery.

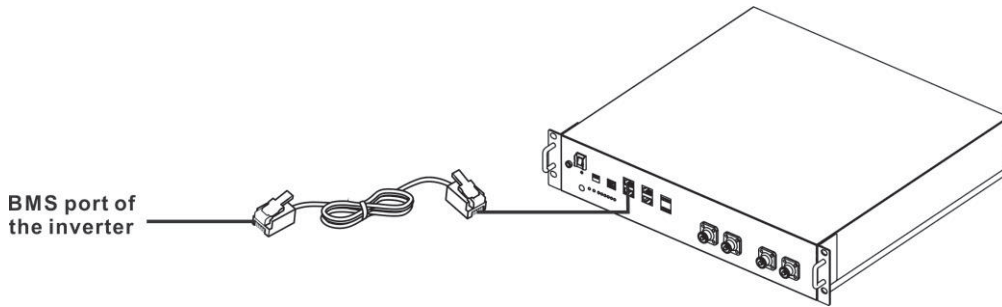

Step 2. Switch on Lithium battery.

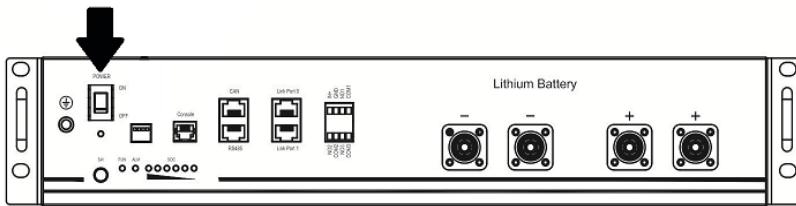

Step 3. Press more than three seconds to start Lithium battery. Output power is ready.

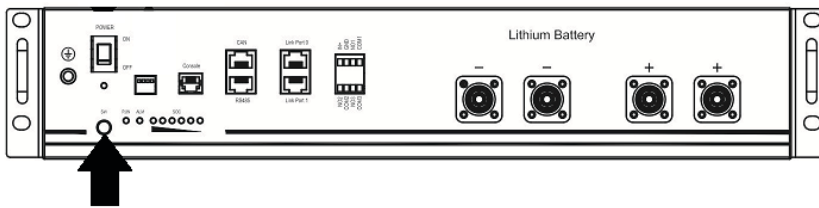

Step 4. Turn on the inverter.

Step 5. Be sure to select battery type as "PYL" in LCD program 5.

05 PYL

If communication between the inverter and battery is successful, the battery icon  on LCD display will flash. Generally speaking, it will take longer than 1 minute to establish communication.

WECO

Step 1. Use a custom-made RJ45 cable to connect inverter and Lithium battery.

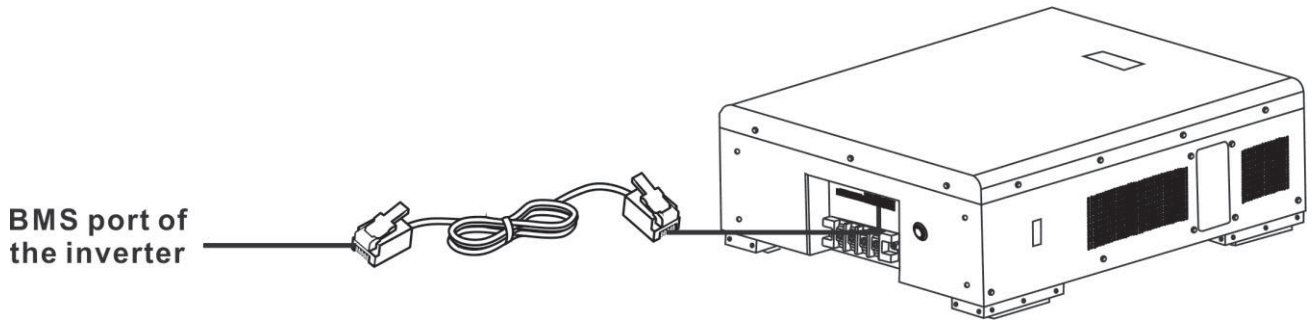

Step 2. Switch on Lithium battery.

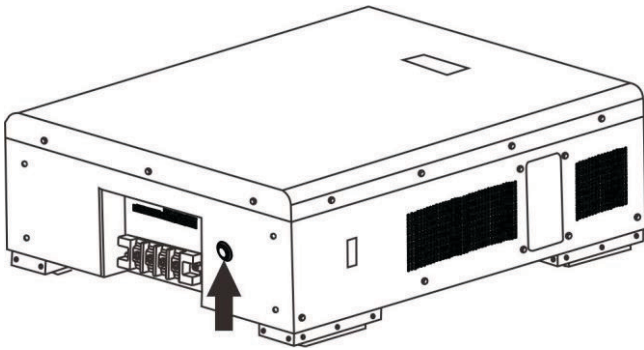

Step 3. Turn on the inverter.

Step 4. Be sure to select battery type as "WEC" in LCD program 5.

05 WEC

If communication between the inverter and battery is successful, the battery icon  on LCD display will "flash". Generally speaking, it will take longer than 1 minute to establish communication.

SOLTARO

Step 1. Use a custom-made RJ45 cable to connect inverter and Lithium battery.

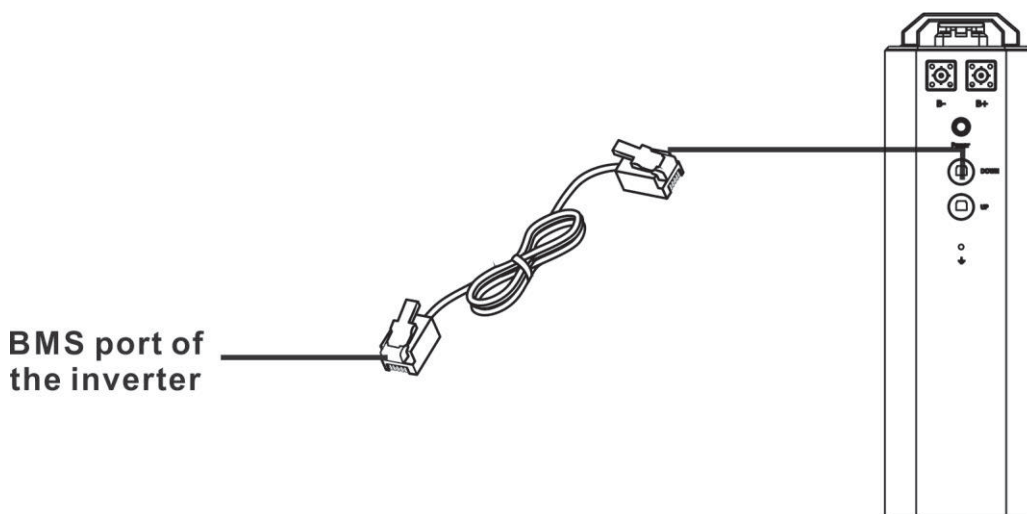

Step 2. Open DC isolator and switch on Lithium battery.

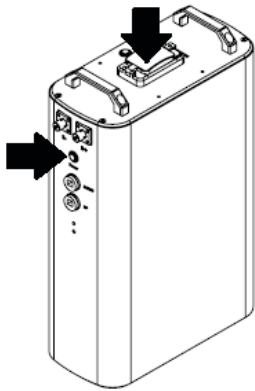

Step 3. Turn on the inverter.

Step 4. Be sure to select battery type as "SOL" in LCD program 5.



If communication between the inverter and battery is successful, the battery icon on LCD display will "flash". Generally speaking, it will take longer than 1 minute to establish communication.

5. LCD Display Information

Press "UP" or "DOWN" button to switch LCD display information. It will show battery pack and battery group number before "Main CPU version checking" as shown below.





| Selectable information | LCD display |
|----------------------------------------------|------------------------------------------------------------------------------|
| Battery pack numbers & Battery group numbers | <p>Battery pack numbers = 3, battery group numbers = 1</p> <p>bn5 03 001</p> |

Active Function

This function is to activate lithium battery automatically while commissioning. After battery wiring and commissioning is successfully, if battery is not detected, the inverter will automatically activate battery if the inverter is powered on.

5. Code Reference

Related information code will be displayed on LCD screen. Please check inverter LCD screen for the operation.

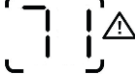
| Code | Description |
|-------------------------------------------------------------------------------------|---------------------------------------------------------------------------------------------------------------------------------------------------------------------------------------------------------------------------------------------------------------------------------------------------------------------------------------------------------------------------------------------------------------------------------------------------------------------------|
|  | If battery status is not allowed to charge and discharge after the communication between the inverter and battery is successful, it will show code 60 to stop charging and discharging battery. |
|  | Communication lost (only available when the battery type is setting as any type of lithium-ion battery.) <ul style="list-style-type: none"> • After battery is connected, communication signal is not detected for 3 minutes, buzzer will beep. After 10 minutes, inverter will stop charging and discharging to lithium battery. • Communication lost occurs after the inverter and battery is connected successfully, buzzer beeps immediately. |
|  | Battery number is changed. It probably is because of communication lost between battery packs. Please check the cables between the batteries. |
|  | If battery status is not allowed to charge after the communication between the inverter and battery is successful, it will show code 69 to stop charging battery. |
|  | If battery status must be charged after the communication between the inverter and battery is successful, it will show code 70 to charge battery. |
|  | If battery status is not allowed to discharge after the communication between the inverter and battery is successful, it will show code 71 to stop discharging battery. |

Appendix II: The Wi-Fi Operation Guide in Remote Panel (Option)

1. Introduction

Wi-Fi module can enable wireless communication between off-grid inverters and monitoring platform. Users have complete and remote monitoring and controlling experience for inverters when combining Wi-Fi module with WatchPower APP, available for both iOS and Android based device. All data loggers and parameters are saved in iCloud.

The major functions of this APP:

- Delivers device status during normal operation.
- Allows to configure device setting after installation.
- Notifies users when a warning or alarm occurs.
- Allows users to query inverter history data.



2. WatchPower App

2-1. Download and install APP

Operating system requirement for your smart phone:

🍏 iOS system supports iOS 9.0 and above

🤖 Android system supports Android 5.0 and above

Please scan the following QR code with your smart phone and download WatchPower App.



Android system





iOS system

Or you may find "WatchPower" app from the Apple® Store or "WatchPower Wi-Fi" in Google® Play Store.



2-2. Initial Setup

Step 1: Registration at first time

After the installation, please tap the shortcut icon  to access this APP on your mobile screen. In the screen, tap "Register" to access "User Registration" page. Fill in all required information and scan the remote box PN by tapping  icon. Or you can simply enter PN directly. Then, tap "Register" button.



Don't have an account? Please [Register](#)

Then, a "Registration success" window will pop up. Tap "Go now" to continue setting local Wi-Fi network connection.

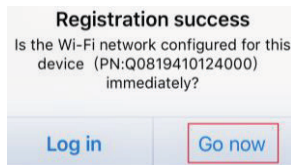

Step 2: Local Wi-Fi Module Configuration

Now, you are in "Wi-Fi Config" page. There are detailed setup procedure listed in "How to connect?" section and you may follow it to connect Wi-Fi.

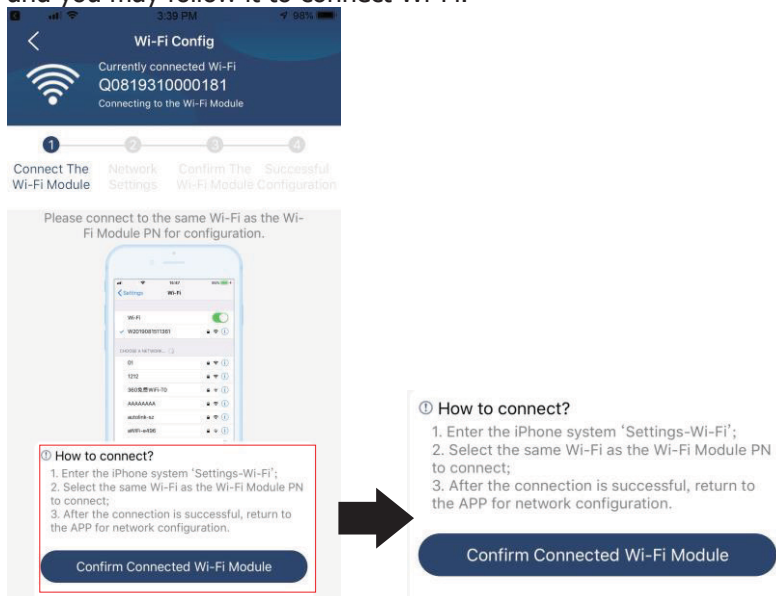

Enter the "Settings→Wi-Fi" and select connected Wi-Fi name. The connected Wi-Fi name is the same to your Wi-Fi PN number and enter default password "12345678".

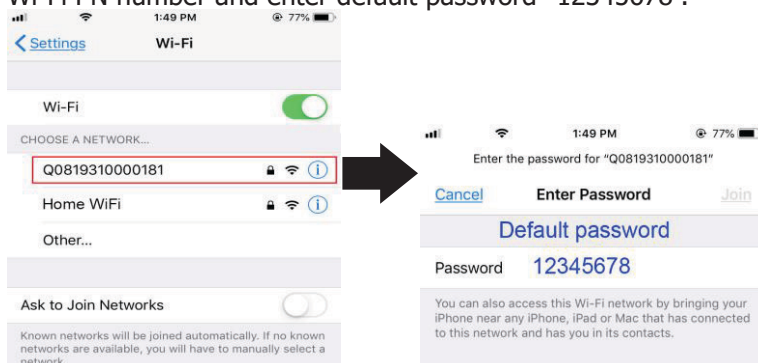

Then, return to WatchPower APP and tap "  " button when Wi-Fi module is connected successfully.

Step 3: Wi-Fi Network settings

Tap  icon to select your local Wi-Fi router name (to access the internet) and enter password.

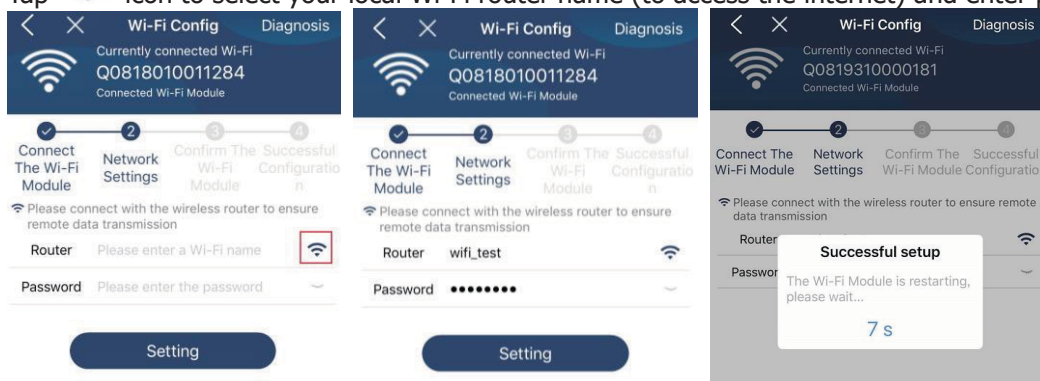

Step 4: Tap "Confirm" to complete the Wi-Fi configuration between the Wi-Fi module and the Internet.

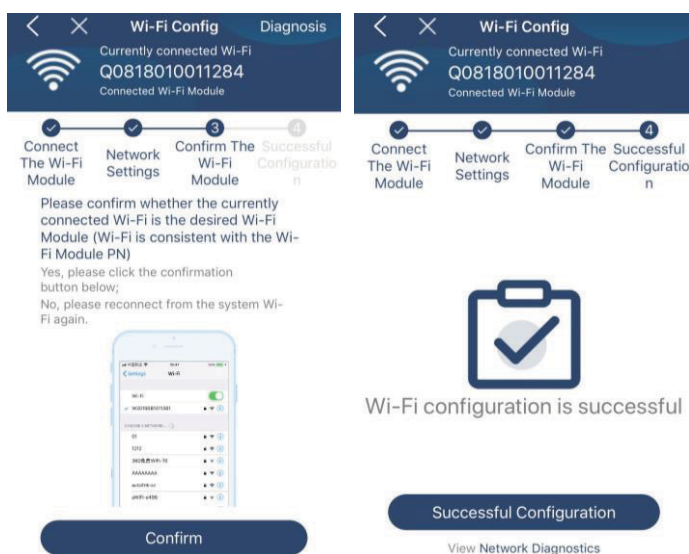

If the connection fails, please repeat Step 2 and 3.

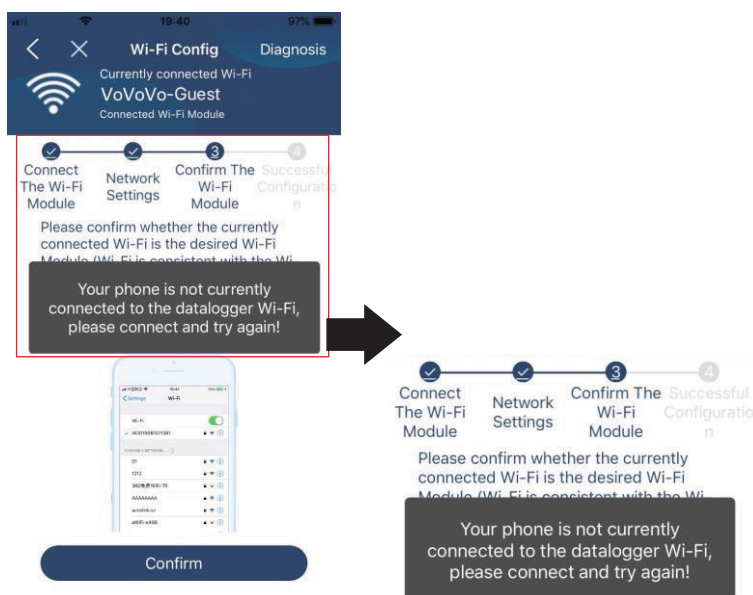

Diagnose Function

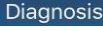
If the module is not monitoring properly, please tap "  " on the top right corner of the screen for further details. It will show repair suggestion. Please follow it to fix the problem. Then, repeat the steps in the chapter 4.2 to re-set network setting. After all setting, tap "Rediagnosis" to re-connect again.

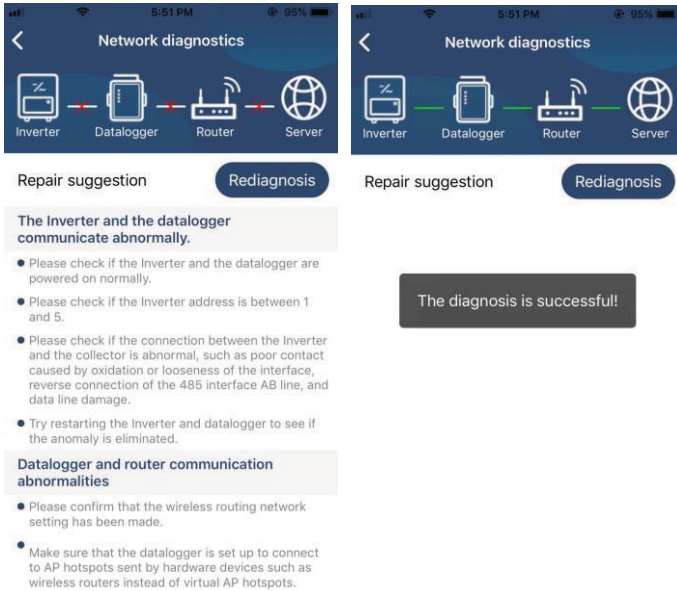

2-3. Login and APP Main Function

After finishing the registration and local Wi-Fi configuration, enter registered name and password to login.
 Note: Tick "Remember Me" for your login convenience afterwards.

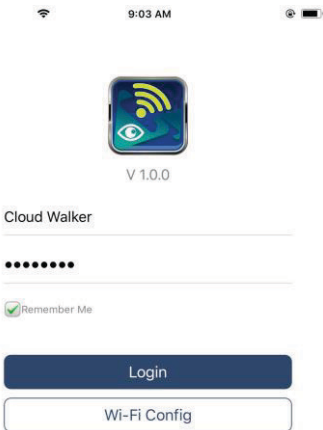

Overview

After login is successfully, you can access "Overview" page to have overview of your monitoring devices, including overall operation situation and Energy information for Current power and Today power as below diagram.

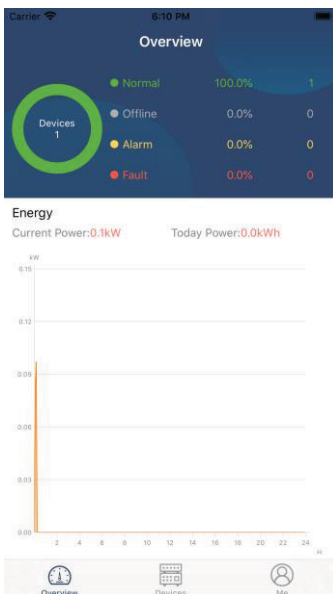

Devices

Tap the  icon (located on the bottom) to enter Device List page. You can review all devices here by adding or deleting Wi-Fi Module in this page.

Add device

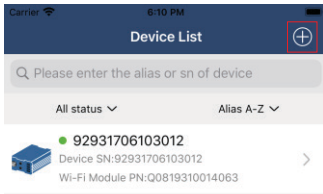

Delete device (swipe left)

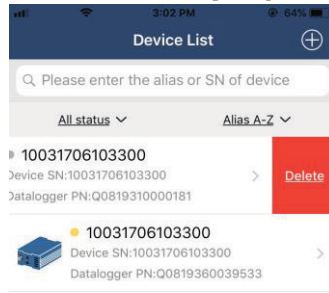

Tap  icon on the top right corner and manually enter part number to add device. This part number label is pasted on the bottom of remote LCD panel. After entering part number, tap "Confirm" to add this device in the Device list.

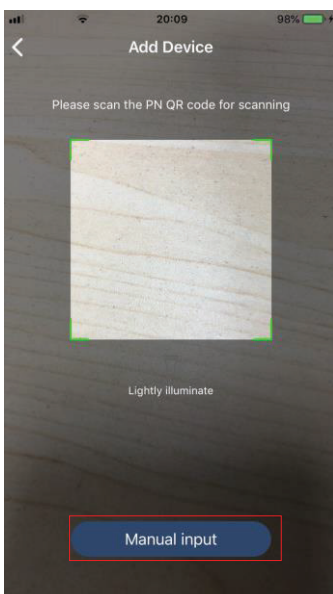

Part number label is pasted on the bottom of remote LCD panel.

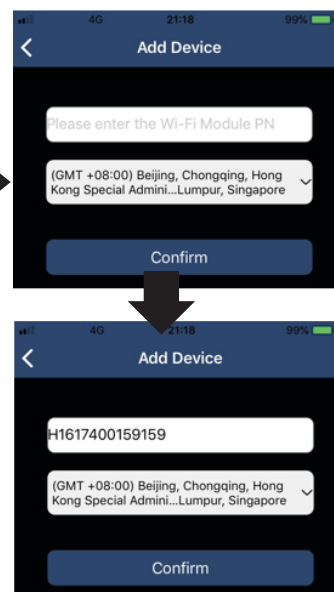

For more information about Device List, please refer to the section 2.4.

ME

In ME page, users can modify "My information", including **【User's Photo】** , **【Account security】** , **【Modify password】** , **【Clear cache】** ,and **【Log-out】** , shown as below diagrams.

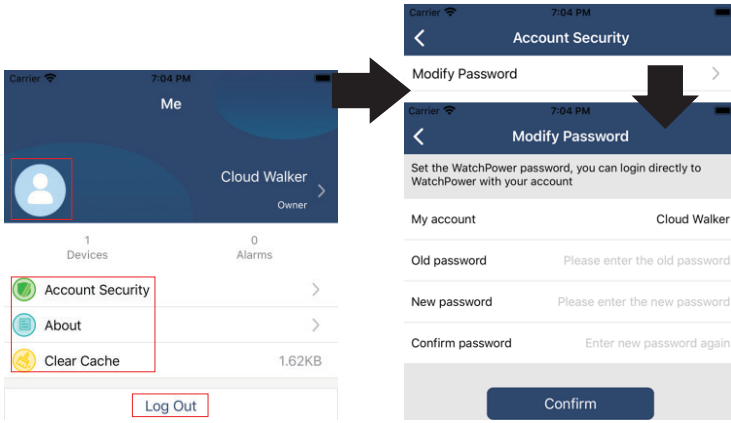

2-4. Device List

In Device List page, you can pull down to refresh the device information and then tap any device you want to check up for its real-time status and related information as well as to change parameter settings. Please refer to the parameter setting list.

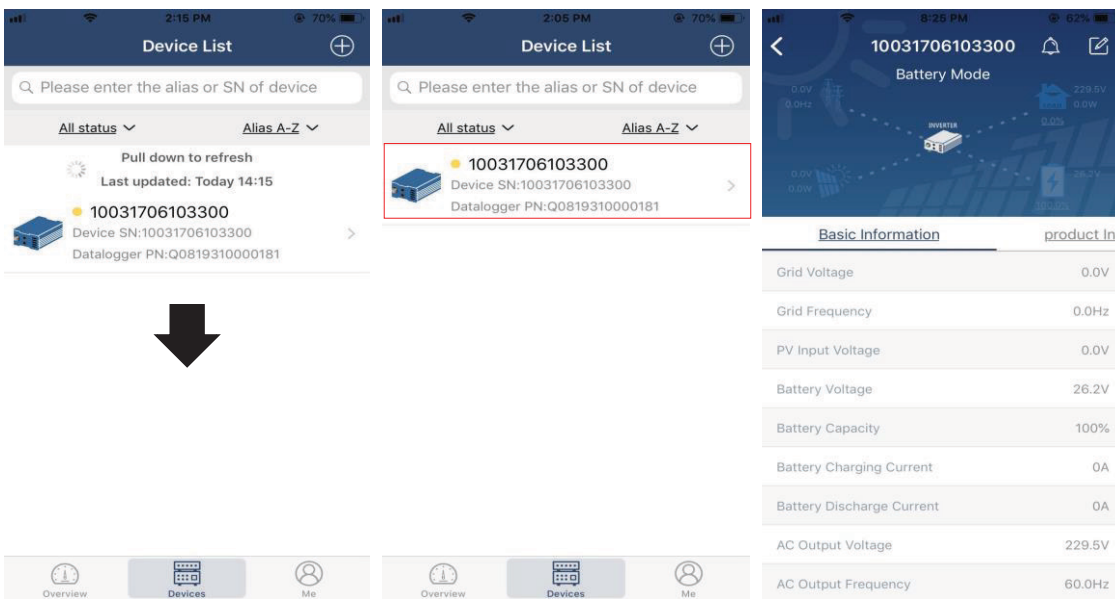

Device Mode

On the top of screen, there is a dynamic power flow chart to show live operation. It contains five icons to present PV power, inverter, load, utility and battery. Based on your inverter model status, there will be **[Standby Mode]** , **[Line Mode]** , **[Battery Mode]** .

[Standby Mode] Inverter will not power the load until "ON" switch is pressed. Qualified utility or PV source can charge battery in standby mode.

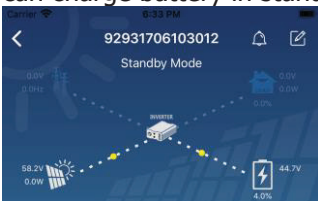

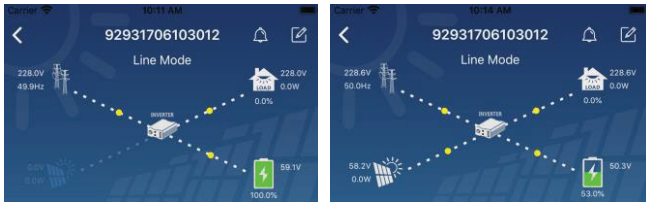

[Line Mode] Inverter will power the load from the utility with or without PV charging. Qualified utility or PV source can charge battery.

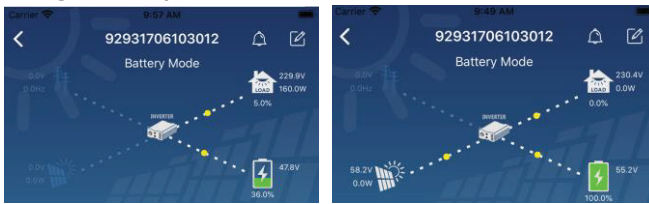

[Battery Mode] Inverter will power the load from the batter with or without PV charging. Only PV source can charge battery.



Device Alarm and Name Modification

In this page, tap the  icon on the top right corner to enter the device alarm page. Then, you can review alarm history and detailed information. Tap the  icon on the top right corner, a blank input box will pop out. Then, you can edit the name for your device and tap "Confirm" to complete name modification.

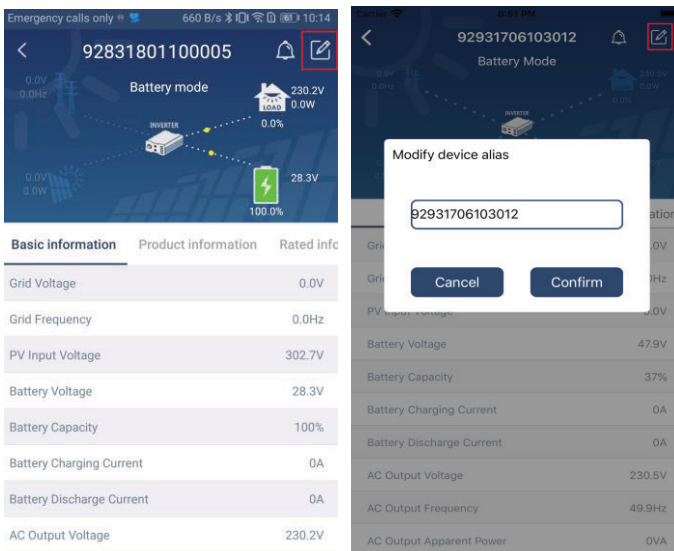

Device Information Data

Users can check up **[Basic Information]** , **[Product Information]** , **[Rated information]** , **[History]** , and **[Wi-Fi Module Information]** by swiping left.

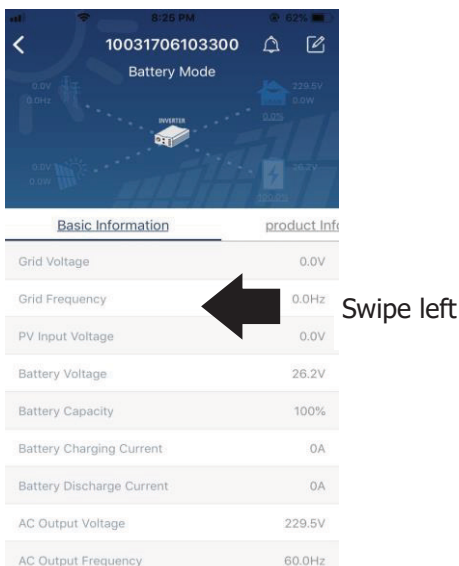

【Basic Information】 displays basic information of the inverter, including AC voltage, AC frequency, PV input voltage, Battery voltage, Battery capacity, Charging current, Output voltage, Output frequency, Output apparent power, Output active power and Load percent. Please slide up to see more basic information.

【Production Information】 displays Model type (Inverter type), Main CPU version, secondary CPU version and WiFi version.

【Rated Information】 displays information of Nominal AC voltage, Nominal AC current, Rated battery voltage, Nominal output voltage, Nominal output frequency, Nominal output current, Nominal output apparent power and Nominal output active power. Please slide up to see more rated information.

【History】 displays the record of unit information and setting timely.

【Wi-Fi Module Information】 displays of Wi-Fi Module PN, status and firmware version.

Parameter Setting

This page is to activate some features and set up parameters for inverters. Please be noted that the listing in "Parameter Setting" page in below diagram may differ from the models of monitored inverter. Here will briefly highlight some of it, **【Output Setting】**, **【Battery Parameter Setting】**, **【Enable/ Disable items】**, **【Restore to the defaults】** to illustrate.

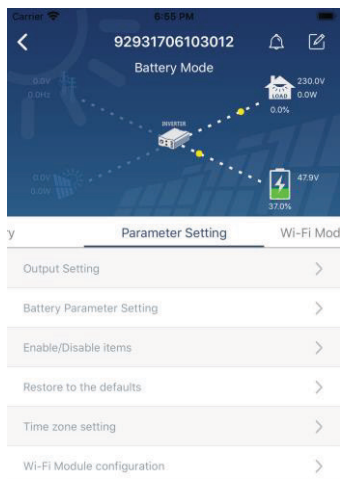

There are three ways to modify setting and they vary according to each parameter.

- a) Listing options to change values by tapping one of it.
- b) Activate/Shut down functions by clicking "Enable" or "Disable" button.
- c) Changing values by clicking arrows or entering the numbers directly in the column.

Each function setting is saved by clicking "Set" button.

Please refer to below parameter setting list for an overall description and be noted that the available parameters may vary depending on different models. Please always see the original product manual for detailed setting instructions.

Parameter setting list:

| Item | Description | |
|----------------|------------------------|-----------------------------------------------------------------------------------------------------------|
| Output setting | Output source priority | To configure load power source priority. |
| | AC input range | When selecting "UPS", it's allowed to connect personal computer. Please check product manual for details. |
| | | When selecting "Appliance", it's allowed to connect home appliances. |
| | Output voltage | To set output voltage. |
| | Output frequency | To set output frequency. |

| Item | Description | |
|---------------------------|--------------------------------------------------------------------|----------------------------------------------------------------------------------------------------------------------------------------------------------------------------------------------|
| Battery parameter setting | Battery type: | To set connected battery type. |
| | Battery cut-off voltage/SOC | To set the battery stop discharging voltage or SOC. Please see product manual for the recommended voltage or SOC range based on connected battery type. |
| | Back to grid voltage/SOC | When "SBU" or "SOL" is set as output source priority and battery voltage is lower than this setting voltage or SOC, unit will transfer to line mode and the grid will provide power to load. |
| | Back to discharge voltage/SOC | When "SBU" or "SOL" is set as output source priority and battery voltage is higher than this setting voltage or SOC, battery will be allowed to discharge. |
| | Charger source priority: | To configure charger source priority. |
| | Max. charging current | It's to set up battery charging parameters. The selectable values in different inverter model may vary. Please see product manual for the details. |
| | Max. AC charging current: | |
| | Float charging voltage | |
| | Bulk charging voltage | It's to set up battery charging parameters. The selectable values in different inverter model may vary. Please see product manual for the details. |
| | Battery equalization | Enable or disable battery equalization function. |
| | Real-time Activate Battery Equalization | It's real-time action to activate battery equalization. |
| | Equalized Time Out | To set up the duration time for battery equalization. |
| | Equalized Time | To set up the extended time to continue battery equalization. |
| | Equalization Period | To set up the frequency for battery equalization. |
| Equalization Voltage | To set up the battery equalization voltage. | |
| Enable/Disable Functions | LCD Auto-return to Main screen | If enable, LCD screen will return to its main screen after one minute automatically. |
| | Fault Code Record | If enabled, fault code will be recorded in the inverter when any fault happens. |
| | Backlight | If disabled, LCD backlight will be off when panel button is not operated for 1 minute. |
| | Bypass Function | If enabled, unit will transfer to line mode when overload happened in battery mode. |
| | Beeps while primary source interrupt | If enabled, buzzer will alarm when primary source is abnormal. |
| | Over Temperature Auto Restart | If disabled, the unit won't be restarted after over-temperature fault is solved. |
| | Overload Auto Restart | If disabled, the unit won't be restarted after overload occurs. |
| | Buzzer | If disabled, buzzer won't be on when alarm/fault occurred. |
| Restore to the default | This function is to restore all settings back to default settings. | |